

CipherLab Reference Manual

8700 Series Mobile Computer

8700/8770/8790

Version 1.00



Copyright © 2011 CIPHERLAB CO., LTD.
All rights reserved

The software contains proprietary information of CIPHERLAB CO., LTD.; it is provided under a license agreement containing restrictions on use and disclosure and is also protected by copyright law. Reverse engineering of the software is prohibited.

Due to continued product development this information may change without notice. The information and intellectual property contained herein is confidential between CIPHERLAB and the client and remains the exclusive property of CIPHERLAB CO., LTD. If you find any problems in the documentation, please report them to us in writing. CIPHERLAB does not warrant that this document is error-free.

No part of this publication may be reproduced, stored in a retrieval system, or transmitted in any form or by any means, electronic, mechanical, photocopying, recording or otherwise without the prior written permission of CIPHERLAB CO., LTD.

For product consultancy and technical support, please contact your local sales representative. Also, you may visit our web site for more information.

The CipherLab logo is a registered trademark of CIPHERLAB CO., LTD.

All brand, product and service, and trademark names are the property of their registered owners.

The editorial use of these names is for identification as well as to the benefit of the owners, with no intention of infringement.

CIPHERLAB CO., LTD.

Website: <http://www.cipherlab.com>

IMPORTANT NOTICES

FOR USA

This equipment has been tested and found to comply with the limits for a **Class B** digital device, pursuant to Part 15 of the FCC Rules. These limits are designed to provide reasonable protection against harmful interference in a residential installation. This equipment generates, uses and can radiate radio frequency energy and, if not installed and used in accordance with the instructions, may cause harmful interference to radio communications. However, there is no guarantee that interference will not occur in a particular installation. If this equipment does cause harmful interference to radio or television reception, which can be determined by turning the equipment off and on, the user is encouraged to try to correct the interference by one or more of the following measures:

- ▶ Reorient or relocate the receiving antenna.
- ▶ Increase the separation between the equipment and receiver.
- ▶ Connect the equipment into an outlet on a circuit different from that to which the receiver is connected.
- ▶ Consult the dealer or an experienced radio/TV technician for help.

This device complies with Part 15 of the FCC Rules. Operation is subject to the following two conditions: (1) This device may not cause harmful interference, and (2) this device must accept any interference received, including interference that may cause undesired operation.

FOR CANADA

This digital apparatus does not exceed the Class B limits for radio noise emissions from digital apparatus as set out in the interference-causing equipment standard entitled "Digital Apparatus," ICES-003 of Industry Canada.

This device complies with Part 15 of the FCC Rules. Operation is subject to the following two conditions: (1) This device may not cause harmful interference, and (2) this device must accept any interference received, including interference that may cause undesired operation.

Cet appareil numérique respecte les limites de bruits radioélectriques applicables aux appareils numériques de Classe B prescrites dans la norme sur le matériel brouilleur: "Appareils Numériques," NMB-003 édictée par l'Industrie.

FOR HAND-HELD PRODUCT WITH RF FUNCTIONS

This equipment complies with FCC radiation exposure limits set forth for an uncontrolled environment. This equipment should be installed and operated with minimum distance 20 cm between the radiator & your body. It only operated in hand-held used.

If you only transfer data to the host wirelessly, please keep the minimum distance 20 cm between machine & your body.

FOR PRODUCT WITH LASER

CAUTION



This laser component emits FDA / IEC Class 2 laser light at the exit port. Do not stare into beam.

SAFETY PRECAUTIONS

RISK OF EXPLOSION IF BATTERY IS REPLACED BY AN INCORRECT TYPE. DISPOSE OF USED BATTERIES ACCORDING TO THE INSTRUCTIONS.

- ▶ The use of any batteries or charging devices, which are not originally sold or manufactured by CipherLab, will void your warranty and may cause damage to human body or the product itself.
- ▶ DO NOT disassemble, incinerate or short circuit the battery.
- ▶ DO NOT expose the scanner or the battery to any flammable sources.
- ▶ For green-environment issue, it's important that batteries should be recycled in a proper way.
- ▶ Under no circumstances, internal components are self-serviceable.
- ▶ The charging and communication cradle uses an AC power adapter. A socket outlet shall be installed near the equipment and shall be easily accessible. Make sure there is stable power supply for the mobile computer or its peripherals to operate properly.

CARE & MAINTENANCE

- ▶ This mobile computer is intended for industrial logistics use. The mobile computer is rated IP 64, however, it may do damage to the mobile computer when being exposed to extreme temperatures or soaked wet.
- ▶ When the body of the mobile computer gets dirty, use a clean and wet cloth to wipe off the dust. DO NOT use/mix any bleach or cleaner. Always keep the LCD dry.
- ▶ For a liquid crystal display (LCD) or touch screen, use a clean, non-abrasive, lint-free cloth to wipe dust off the screen. DO NOT use any pointed or sharp object to move against the surface.
- ▶ If you want to put away the mobile computer for a period of time, download the collected data to a host computer, and then take out the battery pack. Store the mobile computer and battery pack separately.
- ▶ When the mobile computer resumes its work, the main and backup batteries will take a certain time to become fully charged.
- ▶ If you shall find the mobile computer malfunctioning, write down the specific scenario and consult your local sales representative.

RELEASE NOTES

Version	Date	Notes
1.00	Dec. 22, 2011	Initial release

CONTENTS

- IMPORTANT NOTICES - 3 -**
 - For USA - 3 -
 - For Canada - 3 -
 - For Hand-held Product with RF Functions - 3 -
 - For Product with Laser - 4 -
 - Safety Precautions - 4 -
 - Care & Maintenance - 4 -

- RELEASE NOTES - 5 -**

- INTRODUCTION 1**
 - Getting Familiarized with 8700 2
 - Features 3
 - Inside the Package 3
 - Accessories 4
 - Getting Started 5
 - Inserting Battery & Memory Card 5
 - Inserting SIM Card 7
 - Initial Charging 9
 - Setting Local Time 9
 - Power Management 9

- USING MOBILE COMPUTER 11**
 - 1.1 Battery 11
 - 1.1.1 Main Battery 11
 - 1.1.2 Backup Battery 12
 - 1.1.3 Caution of Low Battery Charge 12
 - 1.2 Memory 13
 - 1.2.1 Read-only Memory (ROM) 13
 - 1.2.2 Random-access Memory (RAM) 13
 - 1.2.3 SD Card 13
 - 1.3 Keypad 14
 - 1.3.1 24-key Layout 14
 - 1.3.2 44-key Layout 18
 - 1.4 LCD 22
 - 1.4.1 Adjusting the Backlight 22
 - 1.4.2 Calibrating the Screen 23
 - 1.5 Notifications 24
 - 1.5.1 Status LED 24
 - 1.5.2 Audio 24
 - 1.5.3 Vibrator 24
 - 1.6 Data Capture 25
 - 1.6.1 Symbolologies Supported 25
 - 1.6.2 RFID Tags Supported 28

1.7 Charging & Communications	30
1.7.1 Interface Cable Options	32
1.7.2 Charging & Communication Cradle	32
1.7.3 Understanding the LED Indicators	35
1.8 SD Card	36
1.8.1 File System	36
1.8.2 Directory	36
1.8.3 File Name	38
LEARNING SOFTWARE ARCHITECTURE	39
2.1 Application Module	41
2.1.1 FORGE Application Generator (AG)	41
2.1.2 MIRROR Emulator (CipherNet)	42
2.1.3 User Program	42
2.2 System Configuration & Core	43
2.2.1 System Menu	43
2.2.2 Kernel	43
2.2.3 Program Manager	43
SYSTEM MENU	45
3.1 Information	46
3.1.1 Understanding Device Code	47
3.2 Settings	48
3.2.1 Clock	48
3.2.2 Backlight	48
3.2.3 Auto Off	49
3.2.4 Power On (& Wakeup Event) Options	49
3.2.5 Key Click	49
3.2.6 System Password	49
3.2.7 Font	50
3.2.8 Screen Calibration	50
3.2.9 USB VCOM No.	50
3.2.10 USB Charge Current	50
3.2.11 Default Set	51
3.2.12 Reset Reader	51
3.2.13 Contrast	51
3.3 Tests	52
3.3.1 Reader	52
3.3.2 Buzzer	52
3.3.3 LCD & LED	52
3.3.4 Keyboard	52
3.3.5 Memory	52
3.3.6 Touch Screen	53
3.3.7 Vibrator	53
3.3.8 Echo Test	53
3.3.9 RFID	53
3.3.10 GPS	54
3.4 Memory	55
3.4.1 Size information	55
3.4.2 Initialize	55
3.5 Power	56

3.6 Load Program	57
3.7 Bluetooth Menu	60
3.7.1 Information	60
3.7.2 Connect Setting	61
3.7.3 Security	62
3.7.4 Echo Tests	62
3.7.5 Pairing Test	65
3.7.6 Frequent Devices	66
3.8 SD Card Menu	67
3.8.1 Run as USB Disk	67
3.8.2 Access SD Card	67
3.9 Serial PPP Menu	69
3.9.1 Information	69
3.9.2 Connection Set	70
3.9.3 Echo Test	70
3.10 Wi-Fi Menu	71
3.10.1 Information	72
3.10.2 Network Setting	73
3.10.3 WLAN Setting	74
3.10.4 Security	76
3.10.5 Echo Tests	77
3.11 DoFTP Menu	80
3.11.1 Local	81
3.11.2 Manual	81
3.12 3.5G Menu	82
3.12.1 Information	82
3.12.2 Security	83
3.12.3 3.5G Setting	84
3.12.4 3.5G Tests	85
PROGRAM MANAGER & KERNEL	87
4.1 Program Manager	87
4.1.1 Download	88
4.1.2 Activate	90
4.1.3 Upload	91
4.2 Kernel	92
4.2.1 Kernel Information	93
4.2.2 Kernel Update	94
4.2.3 Burn-In Test	97
4.2.4 System Menu	97
SPECIFICATIONS	99
DOWNLOAD UTILITY	101
File Types	101
Font File	101
C Programs	101
BASIC Programs	102
ProgLoad.exe	103

TROUBLESHOOTING	105
Cannot turn on when pressing Power key	105
Charging error.....	105
Buzzer seems not working.....	105
LED indicator seems not working.....	105
LCD touch screen seems not working	105
Keypad seems not working	106
Vibrator seems not working.....	106
Mobile computer seems not working.....	106
Cannot scan barcodes	106
Low battery condition.....	106
Barcode or RFID reader problem	106
Cannot decode data after scanning.....	106
Unreadable barcode	106
Un-programmed to read	106
Dirty scan window	106
Out of scanning range.....	107
Cannot transmit/receive data	107
Using RS-232 cable	107
Using USB cable	107
Via Bluetooth	107
Via Wi-Fi	108
KEY REFERENCE TABLES	109
24-key Keypad.....	109
System Defaults	109
44-key Keypad.....	110
System Defaults	110

INTRODUCTION

Answering the industrial demands for versatile, reliable and high-performance computers, CipherLab has developed the 8700 Mobile Computer, a heavyweight for your all-day and all-intensive data collections in harsh environments.

The whole 8700 lineup comes with Bluetooth integrated and provides you with 802.11b/g and 3.5G connectivity to opt for, enabling more sophisticated applications and keeping your business online all the time.

The 8700 Mobile Computer is provided with powerful features to ensure your timely data processing and dispatching even in rigorous industrial environments. It makes an ideal choice for total wireless solution that meets challenges. Being programmable, this handy device works with custom applications or terminal emulators.

This manual guides you through the installation, configuration, and operation of the mobile computer. We recommend that you keep one copy of the manual at hand for quick reference or maintenance purposes. To avoid any improper disposal or operation, read the manual thoroughly before use.

Thank you for choosing CipherLab products!

GETTING FAMILIARIZED WITH 8700

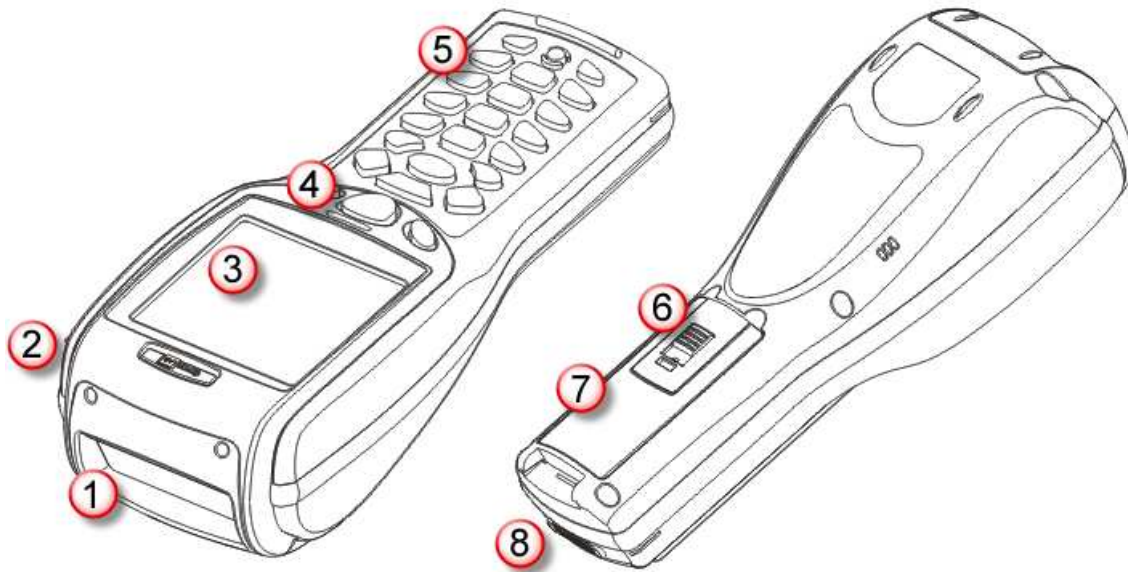

Figure 1: Overview

No.	Description	No.	Description
1	Scanning window	2	Stylus
3	LCD touch screen	4	LED for Good Read, battery charging and wireless data connections
5	Keypad, 24 or 44 keys	6	Battery Latch
7	Li-ion Battery, fit to compartment	8	Direct data-transmission/charging port

Warning: Always make sure the hand strap is well hooked and screwed to the back of the mobile computer before use.

FEATURES

- ▶ Ergonomic design — rugged yet streamlined, with hand strap for secure hold
- ▶ Built tough to survive drop test and sealed against moisture/dust to IP 64
- ▶ Dual mode support — one barcode scan engine plus the RFID reader
- ▶ High capacity memory card (microSDHC) supported
- ▶ Flexible wireless solutions — Bluetooth integrated, with connectivity options for 802.11b/g and 3.5G
- ▶ FTP client support via 802.11b/g
- ▶ Graphic monochrome LCD touch screen supports double-byte characters and bitmap graphics
- ▶ Programmable feedback includes buzzer, LED indicator, and vibrator
- ▶ Quick link to any backend database through MIRROR Emulator programs for VT100/220 and IBM 5250 emulation
- ▶ Easy customization of data collection applications through FORGE Application Generator (AG) programs for preloaded AG Runtime, batch and WLAN versions available
- ▶ Programming support includes BASIC & C compilers
- ▶ Accessories include RS-232 cable, pistol grip, charging and communication cradle, etc.

INSIDE THE PACKAGE

The following items are included in the package. Save the box and packaging material for future use in case you need to store or ship the mobile computer.

- ▶ 8700 Series mobile computer
- ▶ Rechargeable Li-ion battery pack
- ▶ Hand strap
- ▶ Stylus
- ▶ Stylus tether
- ▶ USB Cable
- ▶ Utility CD
- ▶ Quick Start Guide
- ▶ 5V Power Adapter

ACCESSORIES

Rich choices of optional accessories are made available for you to enhance the general performance of the mobile computer.

- ▶ Pistol Grip
- ▶ Belt Holster
- ▶ Protective Cover
- ▶ Spare rechargeable Li-ion battery
- ▶ Standard USB cable
- ▶ RS-232 Cable
- ▶ Universal power adapter
- ▶ 308 USB Virtual COM Interface Cable (convert RS-232 to USB)
- ▶ Charging & Communication Cradle

GETTING STARTED

INSERTING BATTERY & MEMORY CARD

For shipping and storage purposes, save the mobile computer and the main battery in separate packages. This will keep both batteries in good condition for future use.

Note: Any improper handling may reduce the battery life.

To set up the mobile computer to work:

- 1) Hold the mobile computer still and release the hand strap from the bottom of the mobile computer. Remove the battery pack to see the socket for an external SD card. The socket has a hinged cover.
- 2) Slide-release the hinged cover.
- 3) Flip up the hinged cover.
- 4) Fit your memory card (microSD or microSDHC) into the socket.
- 5) Put down the hinged cover.
- 6) Slide-lock the hinged cover.
- 7) Reinstall the battery pack into the battery compartment at a proper angle (30°~45°) that the metal contacts can meet. Make sure the battery is installed in place.
- 8) Slide the battery latch to the lock position.
- 9) Re-join the unfastened end of the hand strap to the mobile computer. Make sure the hand strap is securely attached to the mobile computer before use.
- 10) The hand strap is ideal for one-hand operation and ensures safe and convenient hold of the mobile computer.

Note: For a new battery, make sure it is fully charged before use. Always prepare a spare battery pack, especially when you are on the road.

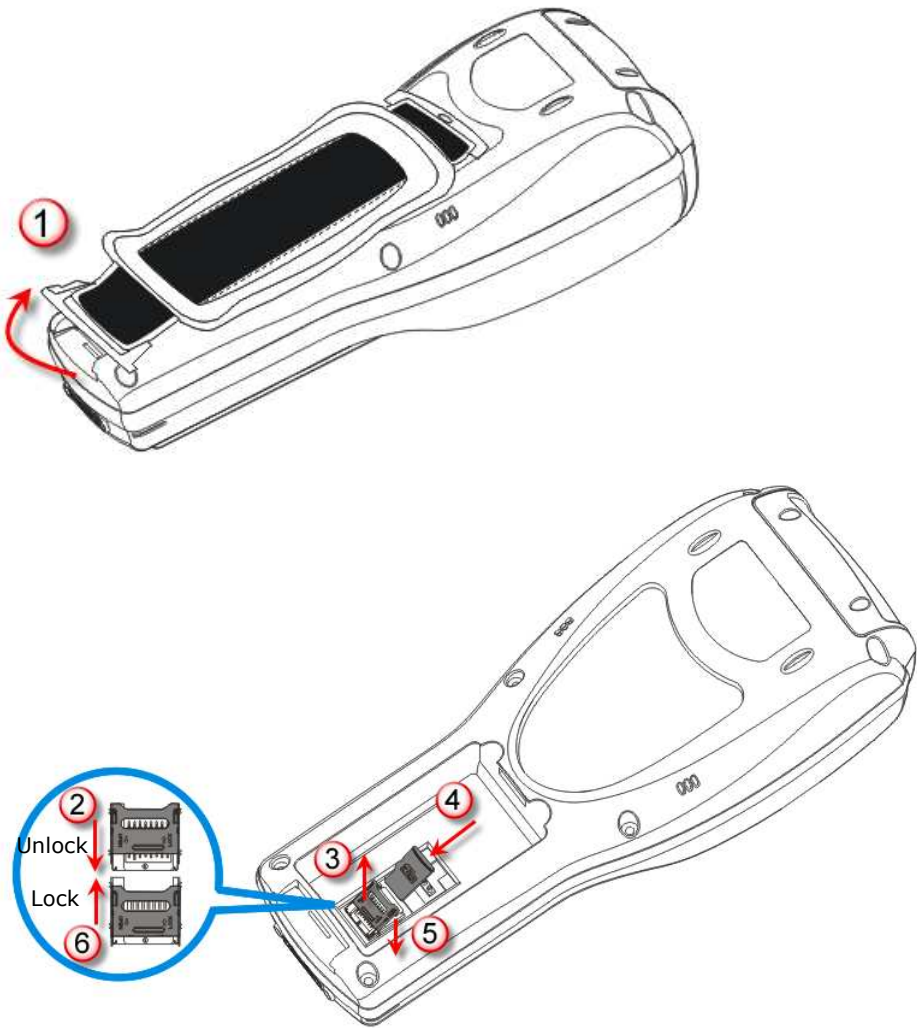

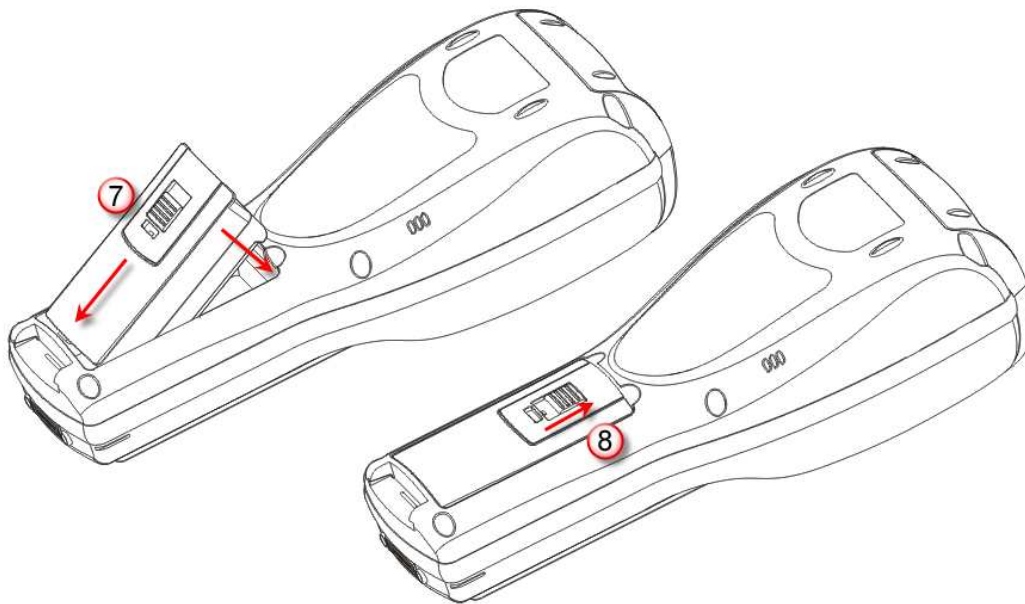

Figure 2: Installing Memory Card & Battery

INSERTING SIM CARD

The 8790 mobile computer is capable of data communications over free air, right on the road.

To insert a SIM card:

- 1) Turn off the mobile computer.
- 2) Remove the top shield by unfastening the four screws.
- 3) Find the SIM card slot inside the top of the mobile computer.
- 4) Insert the SIM card and make sure its gold contacts and notched corner are positioned correctly as shown.
- 5) Restore the top shield by re-fastening the 4 screws.

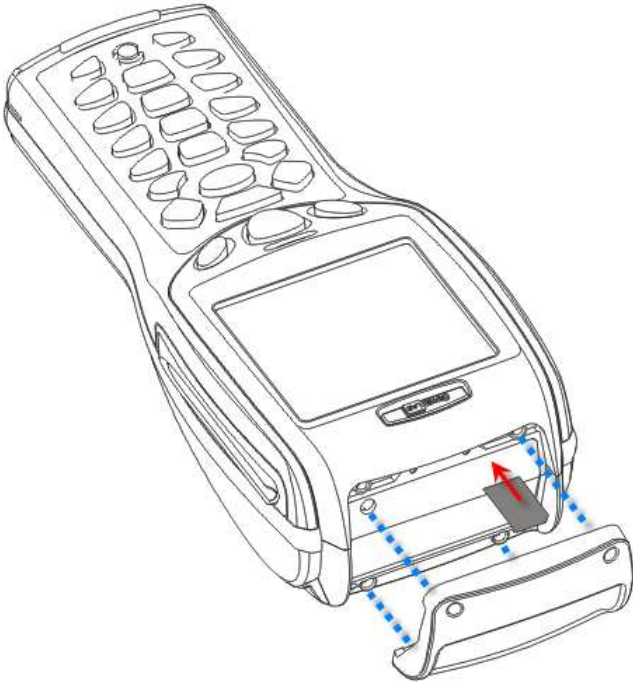

Figure 3: Inserting SIM Card

INITIAL CHARGING

Due to shipment, it is likely the main battery and backup battery aren't fully charged when you receive the package. Before setting the mobile computer to work, charge the main battery to full by direct charging using the power adapter (with the help of the USB Charging & Communication Cable or Cradle). Refer to [1.7 Charging & Communications](#).

Since the main battery is the only source that the backup battery taps power from, be sure to install the main battery when you first charge the mobile computer so both main battery and backup battery get charged.

Some key facts about charging the batteries:

- ▶ Battery charging stops when the temperature drops below 0°C or exceeds 40°C. It is recommended the battery be charged at room temperature (18°C to 25°C) for the optimal performance.
- ▶ For initial charging, it takes approximately 5 hours for the power adapter to charge the battery to full on condition that the mobile computer is turned off.
- ▶ It takes at least 24 hours to fully charge the backup battery. However, it is not necessary to fully charge the backup battery for the mobile computer to work.

Note: In order to charge the backup battery to full, you must insert the main battery and leave it for at least 24 hours, whether the mobile computer is in use or not.

SETTING LOCAL TIME

If you need to set your local time, go to **System Menu | 2. Settings | 1. Clock**. Refer to [3.2.1 Clock](#).

POWER MANAGEMENT

For any portable device, power management is a critical issue especially when you are on the road. Some tips are listed below to help you save battery power.

Warning: Using backlight, wireless connectivity, and peripherals on battery power will substantially reduce battery power.

- ▶ To speed up charging the mobile computer, turn off the mobile computer and seat it in the cradle or use the charging/communication cable.
- ▶ Bring a second battery pack on the road.
- ▶ Disable wireless connectivity, Bluetooth, 802.11b/g or 3.5G when it isn't in use.
- ▶ Go to **System Menu | 2. Settings | 2. Backlight**, and configure backlight duration and brightness. Refer to [3.2.2 Backlight](#).
- ▶ Go to **System Menu | 2. Settings | 3. Auto Off**, and configure the idle time (by minute) before the system shuts down automatically. Refer to [3.2.3 Auto Off](#).

USING MOBILE COMPUTER

This chapter walks you through the features and the functions that 8700 mobile computers deliver. The 8700 lineup includes the following variations:

- ▶ 8700 Bluetooth Class 2
- ▶ 8770 Bluetooth Class 2 + 802.11b/g
- ▶ 8790 Bluetooth Class 2 + 802.11b/g + 3.5G

IN THIS CHAPTER

1.1 Battery.....	11
1.2 Memory.....	13
1.3 Keypad.....	14
1.4 LCD	22
1.5 Notifications.....	24
1.6 Data Capture	25
1.7 Charging & Communications.....	30
1.8 SD Card	36

1.1 BATTERY

1.1.1 MAIN BATTERY

The mobile computer is fed by a rechargeable 3.7 V/4000 mAh Li-ion battery pack. When the mobile computer is turned off, it takes approx. 5 hours to charge it to full from the power adapter (using RS-232 cable or cradle) or approx. 14 hours from the USB cable (at 500 mA).

For power-saving purpose, always turn off the backlight while working in a well-lit area. When the backlight is on for extended periods of time, the main battery will become low sooner than expected.

The smart battery icon on the LCD screen shows the status of power consumption. There are two ways to monitor the battery charge:

- ▶ Examine the level of the 4-bar battery icon on the screen
- ▶ Check up the voltage level by **System Menu** (see [3.5 Power](#))

1.1.2 BACKUP BATTERY

The backup battery on the main board takes the responsibility to supply power to the mobile computer when the main battery is removed or drained out. When fully charged, the 3.0 V/7 mAh rechargeable Lithium button cell helps retain data in SRAM and maintain the running of the real-time clock and calendar for at least 25 days without the main battery. In the meantime, you have to replace the main battery as soon as possible. It takes at least twenty-four hours to fully charge the backup battery. However, it is not necessary to fully charge the backup battery for the mobile computer to work.

- ▶ Monitor voltage level by **System Menu** (see [3.5 Power](#))

1.1.3 CAUTION OF LOW BATTERY CHARGE

The battery pack is the only power source for the mobile computer to work. It also charges the backup battery on the main board so the data stored in SRAM can be retained properly. Therefore when the main battery charge goes low, you need to replace the battery pack with a charged one or charge it as soon as possible. Most of all, you should upload important data on a regular basis.

Warning: Data loss may occur with SRAM during low battery condition. Always save data before running out of power or keep a fresh battery for replacement.

1.2 MEMORY

The collected data can be sent back to a host computer immediately over wireless data connections, or stored in memory (SRAM) for a later upload. The mobile computer is equipped with a calendar chip for accurate time/date logging. When the main battery is removed or drained, the backup battery on the main board takes over to retain the contents of SRAM and keep the real-time clock and calendar running. When fully charged, it keeps said jobs up for at least 25 days.

If you want to put away the mobile computer for a couple of days, you should be aware that data loss occurs when both the main and backup batteries discharge completely. Therefore it is necessary to upload data and files before putting away the mobile computer!

1.2.1 READ-ONLY MEMORY (ROM)

8 megabytes flash memory for storing core, OS, application programs, fonts, etc.

1.2.2 RANDOM-ACCESS MEMORY (RAM)

Options include 4 or 16 megabytes SRAM for storing data. Its contents will be retained by the backup battery.

1.2.3 SD CARD

Secure Digital (SD) card is a flash memory data storage device. High capacity memory card (microSDHC) is supported. Refer to [Inserting Battery & Memory Card](#) for how to insert the microSD or microSDHC card. For more details, refer to [1.8 SD Card](#).

Note: (1) When SD card is present, the card icon will appear on the screen and flash while being accessed.
(2) For an SD card that has never been used on the mobile computer, a message like "Found New SD Card" will be displayed allowing users to scan the card for memory check. If you don't feel the need for an instant check on the memory, you can select cancellation and perform the memory check later through **System Menu**. See [3.8 SD Card Menu](#).

1.3 KEYPAD

For input device, the mobile computer keeps 2 keypad layouts optional, either a 24-key type or a 44-key one. Both keypad gets programmable LED backlight as the screen does. Refer to [1.4 LCD](#) for screen & backlight settings.

Silicon rubber has been chosen for the keys due to durability and easy activation. The key click sound is configurable through programming or via **System Menu**. Refer to [3.2.5 Key Click](#).

1.3.1 24-KEY LAYOUT

The layout of the 24-key keypad is similar to a telephone keypad. It wedges alphanumeric, navigation, function keys, and a few symbol keys. Refer to [Appendix III – Key Reference Tables](#) for all the characters it enters.

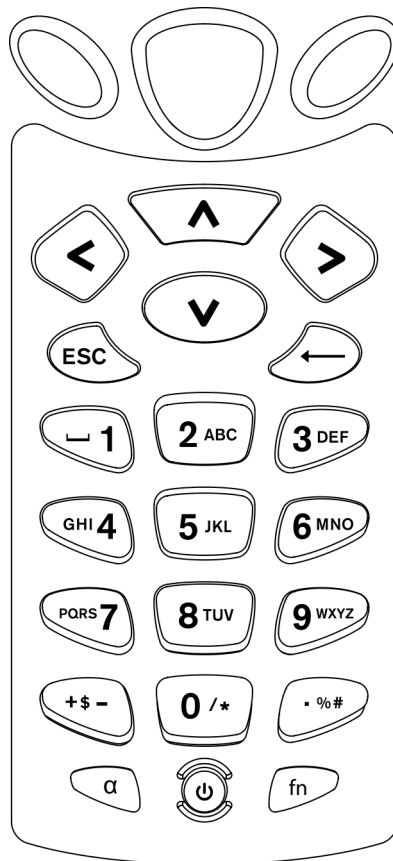





Figure 4: 24-key Layout

This 24-key alphanumeric keypad enters numbers by default. The keypad's alphabet key  switches the keypad to alphabetic input. A few symbols are supported when the keypad sits in alphabetic input, whether uppercase or lowercase.

Press the [a] key  (repeatedly) until the mobile computer shows an "A", which we might as well call "the alphabet icon", at the lower-left of the screen. The keypad starts to enter all caps and a few symbols without holding down the [a] key.

Press the [a] key  (repeatedly) until the mobile computer shows an "a", which we might as well call "the alphabet icon", at the lower-left of the screen. The keypad starts to enter all lowercase letters and a few symbols without holding down the [a] key.

Note the letter case doesn't impact the symbols.

An overview of the alphabet icons and the keypad's input mode:

Alphabet Icons	Keypad's Input Mode
None	Numbers, hyphen minus "-", and dot "."
A	All uppercase letters and symbols
a	All lowercase letters and symbols

When inputting alphabetic characters, the letters and the number printed on a key take turn to show where the cursor is when you keep pressing that key; each press must not exceed one second. For example, when you keep press the number key [2], the letters "A", "B", "C" and the number "2" take turn to show for uppercase while "a", "b", "c" and "2" will take turn to show for lowercase.

- ▶ When you first press the number key [2], the letter "A" or "a" is produced.
- ▶ When you press the number key [2] twice (the time interval must not exceed one second), the letter "B" or "b" is produced.
- ▶ When you press the number key [2] three times (the time interval between each press must not exceed one second), the letter "C" or "c" is produced.
- ▶ When you press the number key [2] four times (the time interval between each press must not exceed one second), the number "2" is produced.

In order to get the desired character, you need to press the same key one to four times (the time interval between each press must not exceed one second). Only when the pressing stops for longer than one second or another key is pressed will the system send out the due key code or change over to send another key code to the active application program.

The [fn] key  is pressed with a number key. Upon your pressing [fn] key, its associated icon **F** displays at the bottom-left of the screen of the mobile computer. Press the second key, say [5], to complete the key combination and produce [F5] function. Then the icon **F** goes off automatically.

Functions of the common keys are briefly described as below:

SCAN



Triggers the scan engine so it reads a barcode when reader function is enabled.

ENTER



The two [Enter] keys on both sides of the [SCAN] key are user-friendly and convenient for both right-handed and left-handed operators.

Both keys execute commands or confirm input.

- ▶ Press the [fn] key then press either of these [Enter] keys to turn on/off the backlight for the LCD and keypad.

Navigation Keys

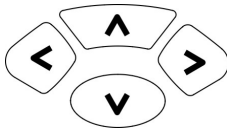

These keys move the cursor left, up, down, or right.

- ▶ Press the [fn] key then press either of up/down key to decrease/increase LCD contrast.
- ▶ Press the [fn] key then press either of left/right key to decrease/increase the LCD backlight brightness.

ESC (Escape)



Stops and quits the current operation.

← (Backspace)



Deletes the preceding character where the cursor is. If this key is pressed and held, a clear code is sent.

α (Alphabet Key)



This key is a modifier key that requires a second key pressed to get the yellow-engraved letters (A~Z) and symbols.

Icon	Description
A	This icon appears at the lower-left of the screen to indicate keypad set to enters all uppercase letters and symbols.
a	This icon appears at the lower-left of the screen to indicate the keypad set to enters all lowercase letters and symbols.

fn (Function Key)

This key is a modifier key that requires a second key ([0] ~ [9]) pressed to deliver the value of key combination.

Icon	Description
E	<p>In default state, the function toggle is set to "Auto Resume" and operates as described below:</p> <ul style="list-style-type: none"> ▶ This icon appears when you press the function key [fn], indicating the keypad set to the function key input. Press a second key to get the desired function. ▶ Once the second key is pressed, the icon goes off automatically.

POWER Key

In order to prevent an accidental press of the POWER key, you need to press and hold this key for approximately 1.5 seconds to turn on/off the mobile computer.

Note: (1) Functionality of keys is application-dependent. The system will send the associated key code to the application program, and it is up to the application program to interpret the key code.

(2) As long as a status icon appears on the screen, it indicates a certain mode has been activated and it isn't necessary to hold the modifier key.

1.3.2 44-KEY LAYOUT

The 44-key keypad wedges numeric, alphabetic, navigation, function keys and the modifier keys. Refer to Appendix III — Key Reference Tables: [44-key Keypad](#) for all the characters it enters.





Figure 5: 44 key Layout

In default state, this 44-key alphanumeric keypad enters numbers and launches the functions of F1 through F15.

THE [ALPHA] KEY

Press the blue modifier key [α] to toggle the keypad among numeric, uppercase alphabetic, and lowercase alphabetic modes.

Press the [α] key  (repeatedly) until the mobile computer shows an "A", which we might as well call the "alphabet icon", at the lower-left of the screen. The keypad starts to enter all uppercase letters without the need to hold down the [α] key.

Press the [α] key  (repeatedly) until the mobile computer shows an "a", which we might as well call the "alphabet icon", at the lower-left of the screen. The keypad starts to enter all lowercase letters without the need to hold down the [α] key.

An overview of the alphabet icons and the keypad's input modes:

Alphabet Icons	Keypad's Input Mode
None	<ul style="list-style-type: none"> ▶ Enters numbers, hyphen minus "-", and dot "." ▶ Launches F1 through F15.
A	All uppercase letters
a	All lowercase letters

THE [FN] KEY

The orange [fn] key makes the keypad enter the orange-engraved characters. After the [fn] key is pressed, it requires you to press a second key to complete the action.

Here are the basics how this [fn] key works: You first press the orange [fn] key  and see an icon **E** shows at the lower-left of the screen. Then you press another key engraved with an orange-colored character/graphic to produce the following:

- 1) Entering that orange-colored character (mostly symbols).
- 2) Launching the functions of F16 through F24.
- 3) Increasing/decreasing backlight brightness for the screen and the keypad.

The [fn] key is set to "Auto Resume" by default, which means the [fn] key is enabled once pressed, and becomes disabled once the second key is pressed.

Here's an example how you produce the function of [F16]:

- 1) Press the orange [fn] key .

The mobile computer's screen shows an **E** at the lower-left of the screen.

- 2) Press the key [F6], which is engraved with the orange-colored "F16".

The system produces the function of [F16].

The icon **E** goes off.

Functions of the common keys are briefly described as below.

SCAN



Triggers the scan engine so it reads a barcode when the reader function is enabled.

ENTER



The two [Enter] keys on both sides of the [SCAN] key are user-friendly and convenient for both right-handed and left-handed operators.

Both of them execute commands or confirm input.

- ▶ Press the [fn] key then press either of these [Enter] keys to turn on/off the backlight of LCD and keypad.

Navigation Keys

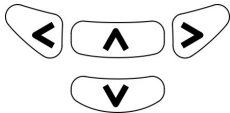

These keys move the cursor left, up, down, or right.

- ▶ Press the [fn] key then press either of up/down key to decrease/increase LCD contrast.
- ▶ Press the [fn] key then press either of left/right key to decrease/increase the LCD backlight brightness.

ESC (Escape)



Stops and quits the current operation.

← (Backspace)



Deletes the preceding character where the cursor is. If this key is pressed and held, a clear code is sent.

␣ (Space)



Inserts a blank space at the position where the cursor is.

⇧ (Tab)



Moves the cursor to the next tab stop.

Ins (Insert)



Switches the keypad between the overtype mode and insert mode. This key is helpful when the mobile computer is working on terminal emulation.

In overtype mode, when you are typing, the cursor overwrites any character that is right after its current position. In insert mode, when you are typing, the cursor inserts a character at its current position.

DEL (Delete)



Deletes the character at the back of the cursor.

α (Alphabet Key)

ⓐ

This key is a modifier key that requires a second key pressed to produce the blue-engraved letters (A~Z).

Icon	Description
A	This icon appears at the lower-left of the screen to indicate keypad set to enter all uppercase letters.
a	This icon appears at the lower-left of the screen to indicate keypad set to enter all lowercase letters.

Alt Key

ⓐ

This key is a modifier key that alters the next key pressed. The functionality depends on the application that is active at the moment.

Icon	Description
A	This icon appears when you press [Alt] to enter the special function mode.

fn (Function Key)

ⓐ

This key is a modifier key that requires a second key pressed to enter the orange-engraved characters (mostly symbols) and produce the function of F16 through F24.

Icon	Description
F	<p>The function toggle is set to "Auto Resume" by default which operates as described below:</p> <ul style="list-style-type: none"> ▶ This icon appears when you press the orange modifier key [fn], indicating the keypad set to function key input. Then you press a second key to enter the desired symbols or produce the desired function. ▶ Once the second key is pressed, the icon F goes off automatically.

Power Key

ⓐ

In order to prevent an accidental press of the POWER key, you need to press and hold down this key for approximately 1.5 seconds to turn on/off the mobile computer.

Note: (1) Functionality of keys is application-dependent. The system will send the associated key code to the application program, and it is up to the application program to interpret the key code.

(2) When a status icon appears on the lower-left of the screen, it indicates a certain mode is activated and it is not necessary to hold down the modifier key.

1.4 LCD

The mobile computer ships with a 3" FSTN graphic LCD, 160 by 160 pixels resolutions, which can be programmed to display text or graphics such as specific font and company logo to meet various applications.

Options	Font Size (pixels)	Characters by lines
English font	Font size 6×8 (pixels)	26 characters by 19 lines
	Font size 8×16 (pixels)	20 characters by 9 lines
Chinese font	Font size 12×12 (pixels)	13 characters by 12 lines
	Font size 16×16 (pixels)	10 characters by 9 lines
Other language fonts, company logo...	Programmable	













Note: The bottom line (ICON_ZONE) is reserved to display status icons, such as the battery icon.

1.4.1 ADJUSTING THE BACKLIGHT

The backlight of screen and keypad makes it easier to operate the mobile computer in dim environments. By pressing the following key combinations, LCD backlight can be turned on/off and the brightness can be adjusted. Keep pressing the key combination until the brightness or contrast decreases or increases to a desired level. Alternatively the brightness and contrast are controllable through programming or via **System Menu**. Refer to [3.2.2 Backlight](#) and [3.2.13 Contrast](#).

Note: Using backlight on battery power will substantially reduce battery power. We suggest that you dim the backlight while working in a well-lit area or set it to automatic power off when the computer isn't actively used.

Use the following key combinations to adjust the backlight for the mobile computer's LCD and keypad, and also the contrast for the LCD. Combine the keys by pressing the [fn] key first and then pressing the second key.

Key Combination		Action
24-key	44 key	
 + [Enter]	 + [Enter]	Toggles on/off the backlight
 + [Up]	 + [Up]	Increases the contrast of LCD
 + [Down]	 + [Down]	Decreases the contrast of LCD
 + [Right]	 + [Right]	Turns on the backlight and increases the brightness of LCD/keypad backlight.
 + [Left]	 + [Left]	Turns on the backlight and decrease the brightness of LCD/keypad backlight.
	 + [3]	Same as  + [Up]

	fn + [6]	Same as fn + [Down]
--	----------	---------------------

1.4.2 CALIBRATING THE SCREEN

This LCD is a touch screen that supports touch control by a stylus. It also features signature capture so signatures can be saved to serve as receipt confirmation when goods are delivered to door.

Refer to [3.2.8 Screen Calibration](#) for screen calibration.

Warning: DO NOT contact the screen surface with any pointed or sharp object.

1.5 NOTIFICATIONS

1.5.1 STATUS LED

A LED indicator is recessed above the [SCAN] button. It presents dual modes and each mode presents dual colors. This LED indicator can be programmed to provide information that helps diagnosing the status of the mobile computer. For example, if you are using AG Runtime, you will be informed of the scanning result immediately. LED1 is used for "Good Read" and will become solid green upon reading a barcode successfully.

- ▶ LED1 provides the information on the charging status and barcode reading.
- ▶ LED2 provides the information on wireless communications.

LED1: Red/Green	Red	Green
User Power ON	User definable	User definable ▶ Solid green for Good Read by default
Power Off, Battery Charging	System default ▶ Flashing red: Charging	System default ▶ Flashing green: Charging done
Charging Error	System default ▶ Flashing red and green: Charging error occurs	
LED2: Blue/Green	Blue	Green
Bluetooth	System default ▶ Flashing blue, quickly: Waiting for connection or connecting ▶ Flashing blue, slowly: Connected	---
Wi-Fi	---	System default ▶ Flashing green, quickly: Waiting for connection or connecting ▶ Flashing green, slowly: Connected

1.5.2 AUDIO

The mobile computer has a low power transducer type buzzer that is programmable for status feedback. In particular, its frequency and duration can be programmed for the alert of Good Read in the provided terminal emulation programs.

1.5.3 VIBRATOR

The mobile computer is integrated with a vibrator that is programmable for status feedback. It makes the mobile computer applicable to work in noisy environments. In particular, the vibrator can be programmed for the alert of Good Read in the provided terminal emulation programs.

1.6 DATA CAPTURE

Options of different reader combination are supported including 1D+RFID and 2D+RFID. For each combination, both readers can be initialized and ready for scanning at the same time (dual mode operation). For example, if you press the [SCAN] trigger while running the preloaded AG runtime on the mobile computer, it will read a barcode in position or an RFID tag in proximity depending on which one comes first.

Note: You cannot have 1D+2D scan engines installed on the mobile computer because they are both barcode readers.

Varying by the reader type installed, the supported symbologies or tag types are listed below:

- ▶ 1D CCD scan engine
- ▶ 1D Laser scan engine
- ▶ 1D Long Range Laser scan engine (LR)
- ▶ 2D scan engine
- ▶ RFID reader

1.6.1 SYMBOLOGIES SUPPORTED

A wide variety of scan engines is available for delivering flexibility to meet different requirements. Depending on the scan engine integrated, the mobile computer is capable of scanning barcodes of a number of symbologies that are enabled by default while running the preloaded AG runtime. Refer to [3.3.1 Reader](#) for functional test.

If you need to scan barcodes that are encoded in a symbology that is disabled by default in AG runtime, **FORGE Application Generator** (ForgeAG.exe) can help you configure symbology settings and reader settings. First, enable the desired symbologies in **FORGE Application Generator**, and then download the application settings to the mobile computer.

Note: In AG or CipherNet runtime, not all of the symbologies are enabled by default. Instead of running any of them, you can develop your own applications to control the scan engine for data collection. For details on configuring reader and symbology settings, please refer to the documentation of the software you use.

Symbologies Supported (Default Setting: Enable/Disable)		CCD/Laser	LR	2D
Codabar		Enabled	Enabled	Enabled
Code 11			Disabled	Disabled
Code 93		Enabled	Enabled	Enabled
Composite Code	CC-A/B			Disabled
	CC-C			Disabled
	TCIF Linked Code 39			Enabled

MSI		Disabled	Disabled	Disabled
Plessey		Disabled		
Postal Codes				Enabled
Telepen		Disabled		
Code 128	Code 128	Enabled	Enabled	Enabled
	GS1-128 (EAN-128)	Enabled	Enabled	Enabled
	ISBT 128	Enabled	Enabled	Enabled
Code 2 of 5	Industrial 25 (Discrete 25)	Enabled	Enabled	Enabled
	Interleaved 25	Enabled	Enabled	Enabled
	Matrix 25	Disabled		Disabled
	Chinese 25			Disabled
	Coop 25	Disabled		
Code 3 of 9	Code 39	Enabled	Enabled	Enabled
	Trioptic Code 39		Disabled	Disabled
	Italian Pharmacode (Code 32)	Disabled	Disabled	Disabled
	French Pharmacode	Disabled		
EAN/UPC	EAN-8	Enabled	Enabled	Enabled
	EAN-8 Addon 2	Disabled	Disabled	Disabled
	EAN-8 Addon 5	Disabled	Disabled	Disabled
	EAN-13	Enabled	Enabled	Enabled
	EAN-13 & UPC-A Addon 2	Disabled	Disabled	Disabled
	EAN-13 & UPC-A Addon 5	Disabled	Disabled	Disabled
	Bookland EAN (ISBN)	Disabled	Disabled	Disabled
	UPC-E0	Enabled	Enabled	Enabled
	UPC-E1	Disabled	Disabled	Disabled
	UPC-E Addon 2	Disabled	Disabled	Disabled
	UPC-E Addon 5	Disabled	Disabled	Disabled
	UPC-A	Enabled	Enabled	Enabled
GS1 DataBar (RSS)	GS1 DataBar Omnidirectional (RSS-14)	Disabled	Enabled	Enabled
	GS1 DataBar Truncated	Disabled	Enabled	Enabled
	GS1 DataBar Stacked	Disabled	Enabled	Enabled
	GS1 DataBar Stacked Omnidirectional	Disabled	Enabled	Enabled
	GS1 DataBar Limited (RSS Limited)	Disabled	Enabled	Enabled
	GS1 DataBar Expanded (RSS Expanded)	Disabled	Enabled	Enabled
	GS1 DataBar Expanded Stacked	Disabled	Enabled	Enabled

2D Symbologies	PDF417			Enabled
	MicroPDF417			Enabled
	Data Matrix			Enabled
	Maxicode			Enabled
	QR Code			Enabled

1.6.2 RFID TAGS SUPPORTED

The RFID reader supports read/write operations depending on the tags. The supported labels include ISO 15693, Icode®, ISO 14443A, and ISO 14443B. Currently, the performance of some tags has been confirmed, and the results are listed below for your reference. Refer to [3.3.9 RFID](#) for functional test.

Note: You should study the specifications of RFID tags before use.

HF Tag	Protocol	UID	Read/Write
ISO 14443A	Mifare Standard 1K (Mifare S50)	✓	✓
	Mifare Standard 4K (Mifare S70)	✓	✓
	Jcop41 (Mifare 1K & 4K compatible)	✓	✓
	Mifare Ultralight	✓	✓
	Mifare Ultralight C	✓	✓
	Mifare ProX	✓	✓
	Mifare DESFire	✓	✓
	Mifare Plus	✓	✓
	Mifare Mini (Mifare S20)	✓	✓
	SLE66CLX320P	✓	--
	SLE55R04 / 08	✓	--
	Smart MX	✓	--
	Jewel	✓	✓
	Topaz	✓	✓
ISO 14443B	SLE6666CL160S	✓	--
	SR176	✓	✓
	SRIX4K	✓	✓
	SLIX4K	✓	✓
Dual	ISO 14443A Compliant	✓	--
	ISO 14443B Compliant	✓	--
ISO 15693	EM4135	✓	✓
	ICODE SLI	✓	✓
	LRI12	✓	✓
	LRI64	✓	✓
	LRI128	✓	✓
	LRI2K	✓	✓
	SRF55V**P	✓	✓
	SRF55V**S	✓	✓

	Tag-it HF-I Std	✓	✓
	TempSense	✓	--
	ICODE1 with EAS&AFI	✓	✓
	ICODE	✓	✓

1.7 CHARGING & COMMUNICATIONS

Normally the mobile computer ships with a USB cable for charging and communications. A variety of cradles are also developed and made available to you to meet your needs.

USB Interface Cable

Task	USB Cable
Charging	USB direct charging <ul style="list-style-type: none"> ▶ 500 mA: USB icon ▶ 0 mA: Disable charging for 8700 5 V charging from the adapter (Plug icon)
Communications	USB Virtual COM — If you have FORGE Application Generator installed on your PC, you may use a download utility to receive data from your PC; or you can run HyperTerminal.exe to receive data directly. USB HID — Run a text editor on your PC to receive data directly. USB Virtual COM_CDC —If you have FORGE Application Generator installed on your PC, you may use a download utility to receive data from your PC; or you can run HyperTerminal.exe to receive data directly.

Note: (1) If you are using USB Virtual COM for the first time, you must install its driver from the CD-ROM. Driver version 5.3 or later is required. Please remove older versions! The virtual COM port will not be assigned until the USB port is in use.
 (2) If you are using USB Virtual COM_CDC for the first time, you must install its driver from the CD-ROM. USB CDC driver installer can be found in the "Windows" folder. It will proceed to install the driver to your PC.
 (3) A standard USB cable releases a COM port in the following conditions: (i) the cable is detached from the mobile computer directly, (ii) the cable is detached from the cradle directly, (iii) the cable is attached to the cradle, but the mobile computer is removed from the cradle, (iv) the mobile computer is powered off, (v) no application that requires a virtual COM port is running on the mobile computer.
 (4) For an application program that requires a COM port to be occupied all the time, it is suggested that you use a 308 USB Virtual COM Interface cable instead.

RS-232 Interface Cable

Task	RS-232 Cable + 5V Power Adapter
Charging	5 V charging from the adapter (Plug icon)
Communications	If you have FORGE Application Generator installed on your PC, you may use a download utility to receive data from your PC; or you can run HyperTerminal.exe to receive data directly.

Cradle

Task	Cradle Interface + 5V Power Adapter
Charging	5 V charging from the adapter (Plug icon)
Communications	Depends on the cradle type and its associated settings — ▶ USB ▶ RS-232

Note: Battery charging stops when the temperature drops below 0°C or exceeds 40°C. It is recommended that the battery be charged at room temperature (18°C to 25°C) for optimal performance.

1.7.1 INTERFACE CABLE OPTIONS

When charging by the USB cable, the standard charging current is 500 mA. However, it is recommended that you charge the mobile computer by the external power source through the power adapter to speed up charging the battery.

- ▶ If you want to disable charging for 8700, change the charging current to 0 mA after connecting the USB cable. Refer to [3.2.10 USB Charge Current](#).

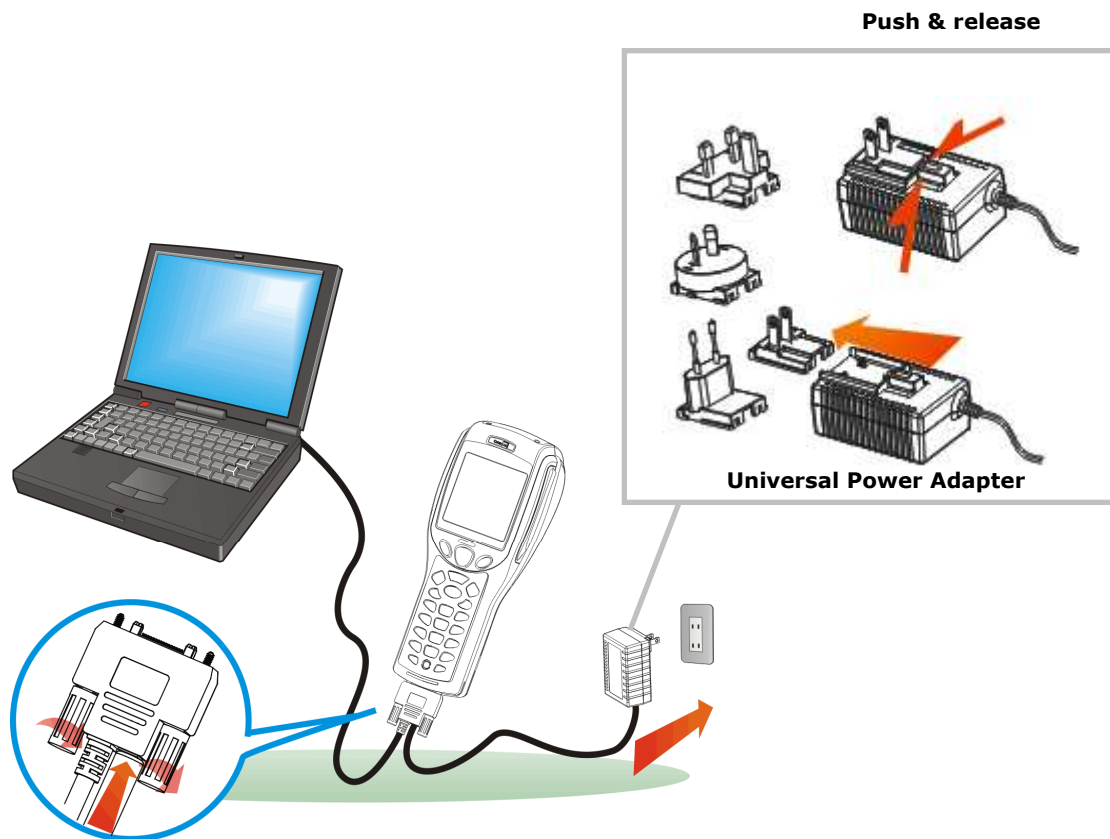

Figure 6: Using USB/RS-232 cable

Warning: It is not allowed for the mobile computer to run solely by USB power without a battery loaded. It will display a warning message "Battery Missing" along with an audible alert. In this case, you should install the battery before restarting.

1.7.2 CHARGING & COMMUNICATION CRADLE

The cradle supports charging and data connection at the same time.

- 1) Seat the mobile computer in the cradle.
- 2) Connect the power supply cord to the power receptacle on the cradle.
- 3) Connect the adapter's wall-wart plug to a power outlet.

- 4) Connect the charging & communication cable if data connection is required.

Note: (1) Tighten the two screw-in connectors to secure the cable.
(2) As the mobile computer will be charged via cradle, the power receptacle on the charging & communication cable is inefficient.



Figure 7: Setting up cradle

Charging & Communication Cradle

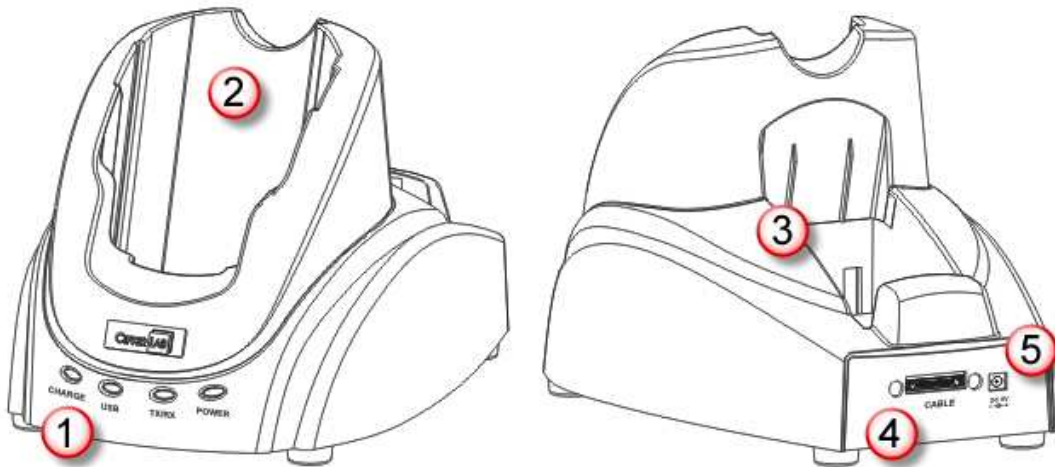

No.	Description	No.	Description
1	LED Indicators (from left to right): <ul style="list-style-type: none"> ▶ Charge ▶ USB ▶ TX/RX ▶ Power Refer to 1.7.3 Understanding the LED Indicators .	2	Charging Slot for the mobile computer
3	Charging Slot for Spare Battery	4	Cable Connector (USB or RS-232)
5	Power Jack		

1.7.3 UNDERSTANDING THE LED INDICATORS

The LED indicators on the cradle deliver the cradle's status. For the charging status of the mobile computer's main battery pack, check out the device's screen.

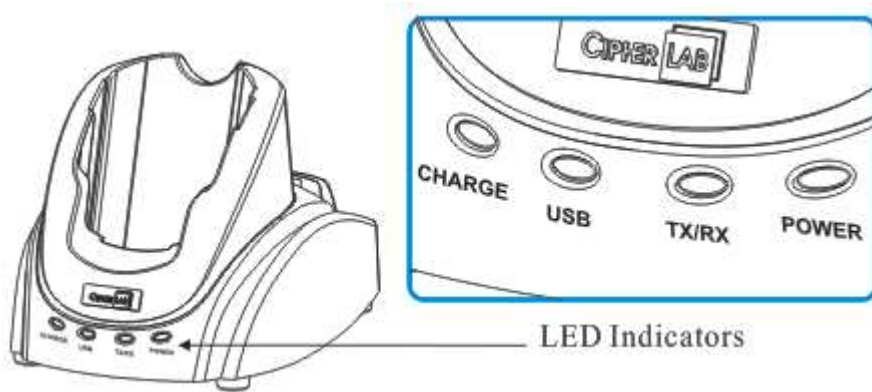

Figure 8: Cradle LEDs

Indicator	Status	Description
Charge	Off	Charging failed
	Red, solid	Charging spare battery
	Green, solid	Charging done
USB	Off	No USB connection
	Green, solid	USB plug-in
TX/RX	Off	No activity
	Green, flashing	Transmitting data via RS-232
POWER	Off	No power
	Red, solid	Power ON

Warning: Charging error may occur due to a power failure or defected battery contacts.

1.8 SD CARD

A SD card inserted in the mobile computer is directly accessible for user's applications. Yet when the mobile computer connects to the host computer via a USB cable, the SD card can work as a removable disk (USB mass storage device) as long as it is configured properly through programming or via **System Menu | 8. Next Page | 1. SD Card Menu | 1. Run As USB Disk**. Refer to [3.8 SD Card Menu](#).

Note: While running BASIC application, the size of DAT files on SD card can be calibrated. Go to **System Menu | 8. Next Page | 1. SD Card Menu | 2. Access SD Card | 4. Check File Size** to refresh the size of "A:\BASICRUN\TXACTn.DAT" (n=1~6).

1.8.1 FILE SYSTEM

For 8700 Series, SD cards of FAT12/FAT16/FAT32 file systems are supported and card formatting through C programming or via **System Menu | 8. Next Page | 1. SD Card Menu | 2. Access SD Card** is supported. Based on the capacity of the card, it will automatically decide the FAT format:

Card Capacity	FAT Format	Sectors per Cluster
> 8 GB	FAT32	16
≤ 32 MB	FAT12	32
≤ 1 GB	FAT16	32
≤ 2 GB	FAT16	64
≤ 8 GB	FAT32	8

1.8.2 DIRECTORY

Unlike the file system on SRAM, the file system on SD card supports hierarchical tree directory structure and allows creating sub-directories. Several directories are reserved for particular use.

Reserved Directory	Related Application or Function	Remark
\Program	<ul style="list-style-type: none"> ▶ System Menu Load Program ▶ Program Manager Download ▶ Program Manager Activate ▶ Kernel Menu Kernel Update ▶ UPDATE_BASIC() 	This directory stores the programs that are downloadable to the mobile computer: <ul style="list-style-type: none"> ▶ C program — *.SHX ▶ BASIC program — *.INI and *.SYN
\BasicRun	BASIC Runtime	This directory stores the DAT and DBF files that are created and accessed in BASIC runtime. They are assigned the permanent filenames as follows:

DAT Filename		
DAT file # 1	TXACT1.DAT	
DAT file # 2	TXACT2.DAT	
DAT file # 3	TXACT3.DAT	
DAT file # 4	TXACT4.DAT	
DAT file # 5	TXACT5.DAT	
DAT file # 6	TXACT6.DAT	
DBF Filename		
DBF file # 1	Record file	F1.DB0
	System Default Index	F1.DB1
	Index file # 1	F1.DB2
	Index file # 2	F1.DB3
	Index file # 3	F1.DB4
DBF file # 2	Record file	F2.DB0
	System Default Index	F2.DB1
	Index file # 1	F2.DB2
	Index file # 2	F2.DB3
	Index file # 3	F2.DB4
DBF file # 3	Record file	F3.DB0
	System Default Index	F3.DB1
	Index file # 1	F3.DB2
	Index file # 2	F3.DB3
	Index file # 3	F3.DB4
DBF file # 4	Record file	F4.DB0
	System Default Index	F4.DB1
	Index file # 1	F4.DB2
	Index file # 2	F4.DB3
	Index file # 3	F4.DB4
DBF file # 5	Record file	F5.DB0
	System Default Index	F5.DB1
	Index file # 1	F5.DB2
	Index file # 2	F5.DB3
	Index file # 3	F5.DB4

\AG\DBF	Application Generator (a.k.a. AG)	This directory stores the DAT, DBF, and Lookup files that are created and/or accessed in Application Generator.
\AG\DAT		
\AG\EXPORT		
\AG\IMPORT		

1.8.3 FILE NAME

A file name must follow 8.3 format (= short filenames) — at most 8 characters for filename, and at most three characters for filename extension. The following characters are unacceptable: " * + , : ; < = > ? | []

- ▶ On 8700 Series, it can only display a filename of 1 ~ 8 characters (the null character not included), and filename extension will be displayed if provided. If a file name specified is longer than eight characters, it will be truncated to eight characters.
- ▶ Long filenames, at most 255 characters, are allowed when using the mobile computer equipped with SD card as a mass storage device. For example, you may have a filename "123456789.txt" created from your PC. However, when the same file is directly accessed on the mobile computer, the filename will be truncated to "123456~1.txt".
- ▶ If a file name is not specified in ASCII characters, in order for the mobile computer to display it correctly, you may need to download a matching font file to the mobile computer first.
- ▶ The file name is not case-sensitive.

LEARNING SOFTWARE ARCHITECTURE

This chapter describes the software preinstalled on the mobile computer — the Kernel, System, and Application, and each has its own function menu.



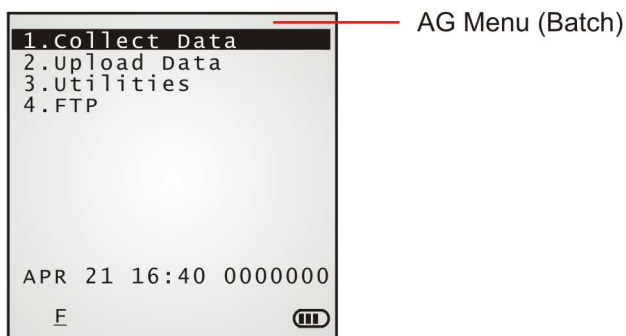
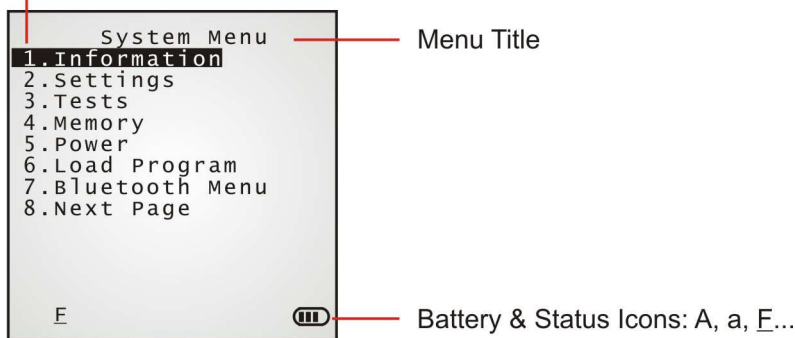

When a menu displays, select an item by either of the following ways:

- ▶ Press the navigation keys [Up] and [Down] to move between the menu items and press [Enter] to select one.
- ▶ Press the number key that corresponds to the menu item to select it.
- ▶ Use a stylus to tap an item from the menu to select it.
- ▶ Follow the on-screen instructions to change a setting, or press [ESC] to return to a previous page or menu.

Item No. (Shortcut keys)



On each screen, the bottom line displays status icons, such as:

- ▶ The 4-bar battery icon indicates the current power status.
- ▶ The status icon of input mode is controlled by the modifier key:  or 
- ▶ The status icon of function mode is controlled by the modifier key:  or 
- ▶ The turn-page icon () indicates there is a previous page or menu. To return to a previous page or menu, you may press [ESC], touch the menu title, or follow the on-screen instructions.

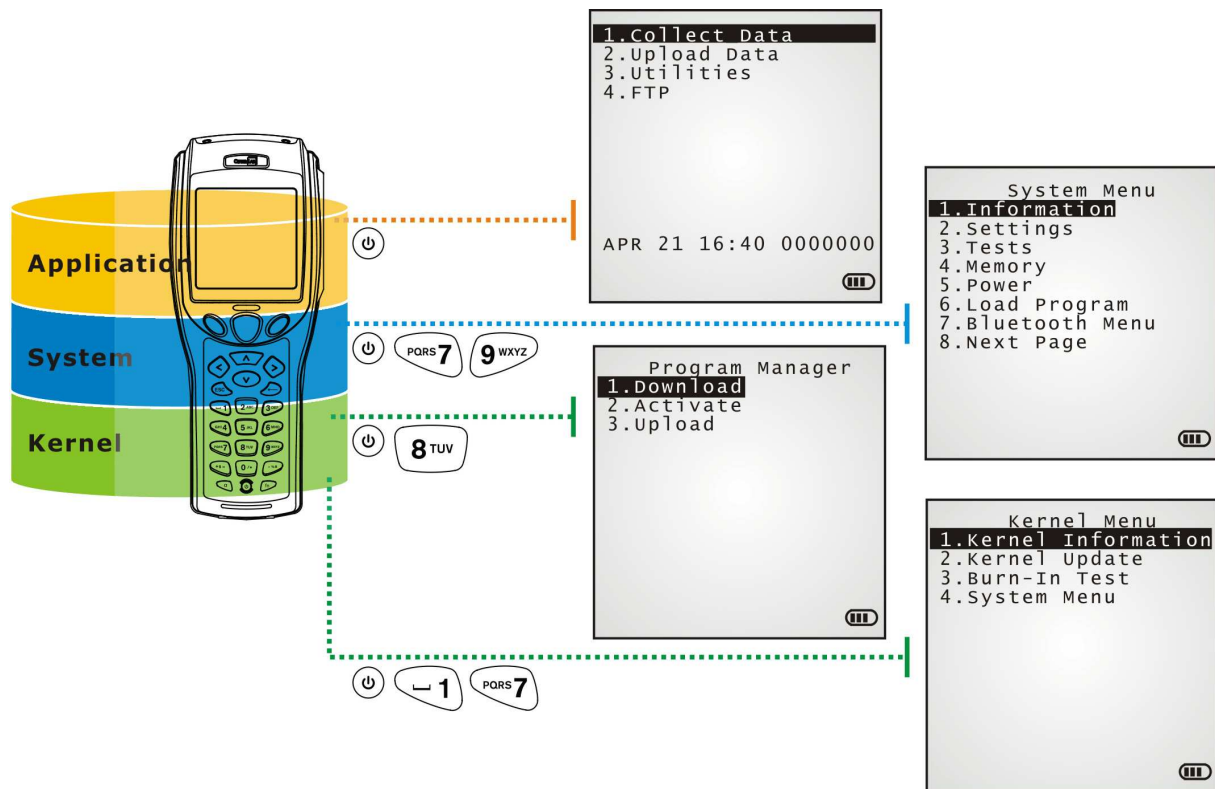

Figure 9: Software Architecture

IN THIS CHAPTER

2.1 Application Module	41
2.2 System Configuration & Core	43

2.1 APPLICATION MODULE

The mobile computer ships with the software package on the CD-ROM. It includes **FORGE Application Generator** (batch- and WLAN-versions), **MIRROR Emulator** (VT and 5250 versions), download utilities, etc.

2.1.1 FORGE APPLICATION GENERATOR (AG)

For the easy development of applications, the mobile computer is preloaded with AG runtime. When you turn on the mobile computer, it displays user application's main menu as below.

Batch AG

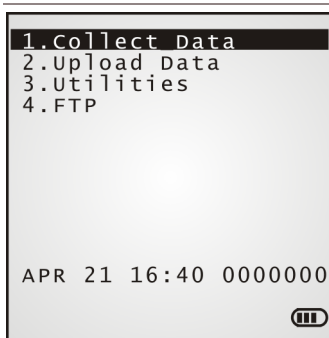

WLAN AG

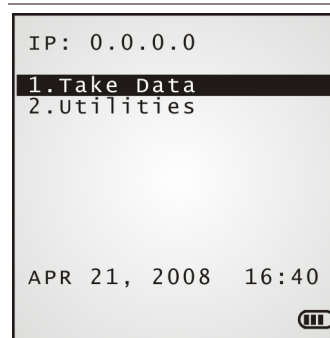

Note: Batch AG supports automatically uploading data to a host computer when the upload interface is properly configured. Once the mobile computer connects to the host via a RS-232 or USB Virtual COM cable, a moving hourglass icon displays on the upper-right corner of the screen to indicate the mobile computer ready for auto upload.

Before you proceed to collect data with the mobile computer, configure the application with the companion tool on your PC. This time-saving development tool helps create mobile computer's application templates on your PC.

For details on the AG application, refer to related user manual.

Application Generator	AG Runtime on mobile computer	Companion Tool on PC
Batch AG	U8700.SHX	ForgeAG.exe
WLAN AG	WU8700.SHX	AG8700WLAN.exe

Note: FORGE Application Generator (AG) software package includes
 (1) a companion tool for quickly developing your application — Batch or WLAN AG;
 (2) several download utilities to make it versatile in use.

2.1.2 MIRROR EMULATOR (CIPHERNET)

The mobile computer supports VT100/220 and IBM 5250 terminal emulation for accessing a backend database. Instead of using **FORGE Application Generator**, you may download the terminal emulation program, i.e. CipherNet Runtime, to the mobile computer. Refer to [3.6 Load Program](#). Then run individual companion tool on your computer.

For details on the **MIRROR Emulator** application, refer to associated user manuals.

Terminal Emulation	CipherNet Runtime on mobile computer	Companion Tool on PC
VT100/220	87xx-VT.SHX	CipherNet-VT.exe
IBM 5250	87xx-5250.SHX	CipherNet-5250.exe

2.1.3 USER PROGRAM

You may need to develop your own application program. For developing custom applications, CipherLab provides BASIC and C compilers through licensing. For detailed information, contact your sales representative.

2.2 SYSTEM CONFIGURATION & CORE

For managing system configurations and multiple programs, each mobile computer comes with **System Menu**, **Program Manager**, and **Kernel Menu**. The following chapters guide you to how the mobile computer is configured for system operation and program download.

2.2.1 SYSTEM MENU

[System Menu](#) is bundled with BASIC Runtime or user programs that are written in "C". It is provided for system configuration, functionality testing, downloading font file and program.

2.2.2 KERNEL

[Kernel](#) is the innermost core of the OS. It provides services for updating the kernel and bootloader, and repairing the system.

2.2.3 PROGRAM MANAGER

[Program Manager](#) is part of the kernel. You may download as many as seven application programs.

SYSTEM MENU

System Menu is a powerful utility that offers an interface for engineers (programmers or system integrators) to view system information, change the configuration parameters, download programs and run diagnostics.

As **System Menu** is intended for engineers' tests and maintenance ONLY, password protection is provided to prevent unauthorized users from accidentally changing system settings.

Warning! **System Menu** is NOT for the use of any end users. The system password helps ensure system safety and integrity.

How to access the System Menu?

- 1) Turn off the mobile computer.
- 2) Press [7] + [9] + [Power] simultaneously.



IN THIS CHAPTER

3.1 Information.....	46
3.2 Settings	48
3.3 Tests	52
3.4 Memory.....	55
3.5 Power	56
3.6 Load Program.....	57
3.7 Bluetooth Menu	60
3.8 SD Card Menu	67
3.9 Serial PPP Menu.....	69
3.10 Wi-Fi Menu.....	71
3.11 DoFTP Menu	80
3.12 3.5G Menu	82

3.1 INFORMATION

Select this command to generate the critical system information that helps diagnose the system.

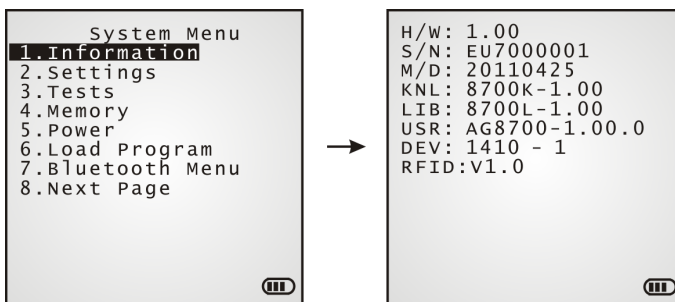

System Menu | 1. Information

H/W	Hardware version
S/N	A serial number assigned to the mobile computer
M/D	Manufacturing date
KNL	Kernel version
LIB	C library version
BSC	BASIC Run-time version. This entry is only present when a BASIC application has been downloaded
USR	Application program version
DEV	5-digit code for the recognition of the embedded hardware modules <ul style="list-style-type: none"> ▶ For example, 1410-1 indicates the 44-key mobile computer is equipped with the CCD scan engine, RFID reader, Bluetooth module, and 802.11b/g connectivity.
RFID	This RFID module version is only present when the 3 rd digit of the Device Code above appears 1.

3.1.1 UNDERSTANDING DEVICE CODE

The device code covers a few pieces of information about the hardware housed inside the mobile computer. The coding rule is tabulated as follows:

Device Code	Modular Component	Coding
1st digit	Reader module	0= none 1= CCD scan engine 2= Laser scan engine 3= 2D scan engine 4= Long Range Laser scan engine
2nd digit	Wireless module	4= Bluetooth + 802.11b/g (8770) 5= Bluetooth only (8700) 7= Bluetooth + 3.5G + 802.11b/g (8790)
3rd digit	RFID, GPS module	0= none 1= RFID reader 2= GPS
4th digit	Reserved	0
5th digit	Keypad layout	0= 24-key 1= 44-key

3.2 SETTINGS

This submenu accesses the mobile computer's system settings and changes their defaults.

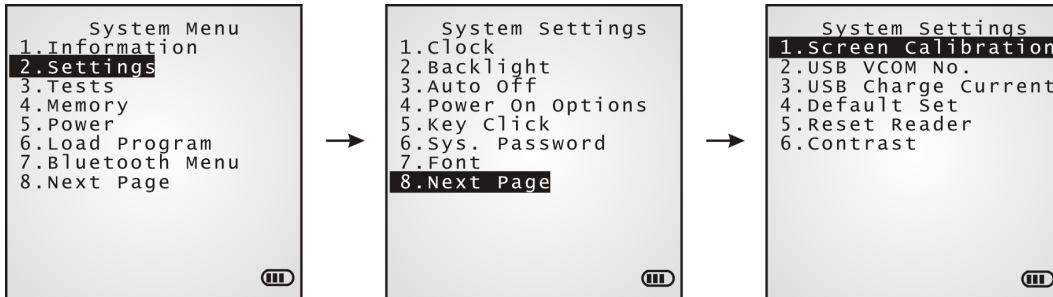

An overview of the defaults:

System Settings	Default Values
Clock	Current time
Backlight	20 seconds, Level 2
Auto Off	10 minutes
Power On Options	Resume
Key Click	Tone 2
System Password	Open access
Font	System font
Screen Calibration	Select this command to align the coordinates of the touch screen with those of the display underneath it, so as to make the touch control precise.
USB VCOM No.	Fixed
USB Charge Current	500 mA
Default Set (=Reset to Default)	Restores your mobile computer to default state.
Reset Reader	Restores the reader to default state.
Contrast	Level 4

3.2.1 CLOCK

Sets the clock / calendar time for the mobile computer. Enter two digits for the year, e.g. 04 for 2004.

3.2.2 BACKLIGHT

Sets the backlight duration for the keypad and LCD.

- ▶ Enter a value between 0 and 9999 (seconds).
- ▶ Press the navigation keys [Up] and [Down] to adjust the backlight level (4 levels).

3.2.3 AUTO OFF

Sets the mobile computer to automatically power off after idleness for a period of time. Enter a value between 0 and 999 (minute).

Note: To disable this function, enter 0.

3.2.4 POWER ON (& WAKEUP EVENT) OPTIONS

This is a submenu that configures how the mobile computer starts up and what event wakes up the mobile computer:

Power On Options

Press the navigation keys [Up] and [Down] to select between "Resume" and "Restart". Press [Enter] to select it.

- ▶ Resume: When the mobile computer is powered on, it resumes the last session of the program that was run before it is turned off.
- ▶ Restart: When the mobile computer is powered on, the system restarts over.

WakeUp Events

The events set can wake up the mobile computer when it takes place. Press the navigation keys [Up] and [Down] to move between the events, and press [Enter] to configure it to enforce the wake-up of the mobile computer or not.

- ▶ PwrKey: If set to yes, the mobile computer wakes up when the power key is pressed.
- ▶ RS232: If set to yes, the mobile computer wakes up when connected to a RS-232 port (by RS232 cable).
- ▶ USB: If set to yes, the mobile computer wakes up when connected with to a USB port (by a USB cable).
- ▶ Charging: If set to yes, the mobile computer wakes up when getting charged via the cradle or direct charging.
- ▶ Charged: If set to yes, the mobile computer wakes up when charging completes.
- ▶ Alarm: If set to yes, the mobile computer wakes up when the alarm time is up. Alarm can be set up through programming only.

3.2.5 KEY CLICK

Sets the audible signal the mobile computer produces when a key is pressed on the keypad. Select a desired tone for the buzzer or mute it.

3.2.6 SYSTEM PASSWORD

Sets a password to control over user's access to the **System Menu**, **Program Manager** and **Kernel Menu**. The password allows up to eight alphanumeric characters.

Note: The password is case-sensitive. To disable a previous password, press both [Enter] when you are asked to "Input new password" and "Verify password".

3.2.7 FONT

Shows the font information. It displays "System Font" if no custom font file is active on the mobile computer. If a multi-language font file is downloaded, you are able to select a font from the list.

3.2.8 SCREEN CALIBRATION

When a touch screen has served for a period of time, it needs calibration to work accurately. Calibration improves the accuracy of the touch screen by aligning the coordinates of the touch panel and the LCD underneath it.

"Screen Calibration" is a command that launches the mobile computer's action directly. Upon your selecting this command, the screen display four cross marks, one at a time at the four corners of the screen. Accurately and firmly tap on the centers of these cross marks using the stylus to follow through the calibration.

Warning: DO NOT use any pointed or sharp object to tap on the screen.

3.2.9 USB VCOM NO.

USB VCOM No. is set to "Fixed" by default. "Fixed" means the mobile computer will always connect to a host computer (such as your PC) by the same USB Virtual COM port regardless of how many mobile computers are connected to it earlier or later.

When the USB VCOM No. is set to "Fixed", you can only connect one mobile computer to your PC at one time. Such setting is helpful to configure a great amount of mobile computers (for administrators' or factory use).

While in other cases, you may need to set USB VCOM No. to "Change with S/N", which means the number of the virtual COM port in use will vary by the serial number of each mobile computer connected to your PC.

- ▶ Press the navigation keys [Up] and [Down] to select between "Fixed" and "Change with Serial Number".

3.2.10 USB CHARGE CURRENT

By default, the USB charging current is set to 500 mA. For direct charging via the USB cable without a power adapter, the standard charging current is 500 mA.

- ▶ Press the navigation keys [Up] and [Down] to select between "500 mA" and "0 mA".
- ▶ To disable charging the mobile computer, select "0 mA".

Note: (1) USB direct charging, 500 mA: USB icon
(2) 5V charging from the adapter: Plug icon

3.2.11 DEFAULT SET

Restores the system settings to default factory state, except for the reader settings.

3.2.12 RESET READER

Restores the reader settings to factory default state.

3.2.13 CONTRAST

Sets the contrast level for the LCD.

- ▶ Press the navigation keys [Up] and [Down] to adjust the contrast level (7 levels).

3.3 TESTS

Provides a variety of functional tests on the mobile computer's key parts.

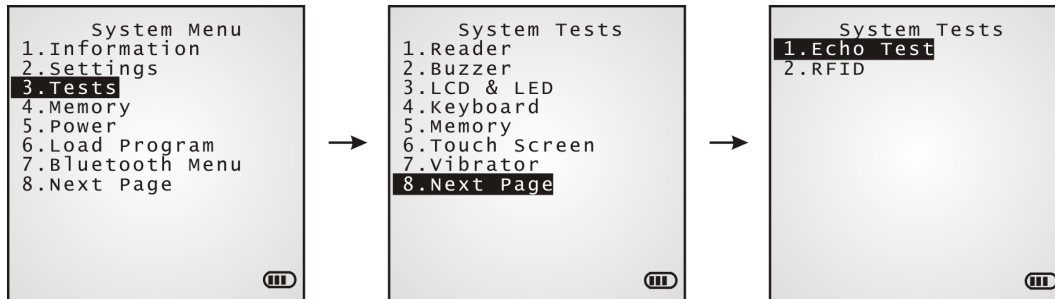

3.3.1 READER

Launches the test on the scanner's reading performance. Symbologies supported depend on the scan engine you use. Refer to [1.6 Data Capture](#) for the symbologies enabled by default. Symbologies disabled by default can only be enabled through programming.

- ▶ Press the [SCAN] key to start testing. To stop and quit the test, press any key.

3.3.2 BUZZER

Launches the buzzer test with different frequency/duration combinations.

- ▶ To stop and quit the test, press any key.

3.3.3 LCD & LED

Launches the test on the LCD display and LED indicator.

- ▶ To stop and quit the test, press any key.

3.3.4 KEYBOARD

Launches the test on the keypad's rubberized keys. Press any key to see if the corresponding character display on the screen.

- ▶ To stop and quit the test, press [ESC].

3.3.5 MEMORY

Launches the test on the mobile computer's data memory (SRAM). The results will display on the screen.

- ▶ To stop and quit the test, press [ESC].

Warning! The contents of the data memory (SRAM) will be wiped out after test.

3.3.6 TOUCH SCREEN

Launches the test on the mobile computer's signature capture with the help of the stylus.

- ▶ To stop and quit the test, press [ESC] or tap [OK] on the screen.

3.3.7 VIBRATOR

Launches the test on the mobile computer's vibrator.

- ▶ To stop and quit the test, press [ESC].

3.3.8 ECHO TEST

Launches the test on the mobile computer's data connection established through the physical USB cable or a RS-232 cable. Run the test utility on your PC while launching this test on the mobile computer. Select a desired baud rate if necessary.

- ▶ To stop and quit the test, press [ESC].

Interface	Description	Test Utility
RS-232	This echo test is to verify the connectivity via the RS-232 cable between the mobile computer and a host computer.	EchoTest.exe
USB	<p>This echo test is to verify the connectivity via the USB cable between the mobile computer and a host computer.</p> <ul style="list-style-type: none"> ▶ USB VCOM Echo — The mobile computer works as a generic USB device. ▶ USB HID — The mobile computer works as an input device; select keyboard type and Caps Lock status for running a test. ▶ USB VCOM_CDC Echo — The mobile computer works as a generic USB device. 	<p>EchoTest.exe for Virtual COM</p> <p>Any text editor for HID</p> <p>EchoTest.exe for Virtual COM</p>

3.3.9 RFID

Launches the test on the RFID reader's reading performance when a proximity card is present. Refer to [1.6.2 RFID Tags Supported](#) for the supported RFID tags.

- ▶ To stop and quit the test, press [ESC].

Note: This test is available only when the RFID module is present.

3.3.10 GPS

Launches the test on the mobile computer's GPS receiver. It gives a general review of the mobile computer's real time speed and position information, and also the satellite count and signal strength.

- ▶ To stop and quit the test, press [ESC].

Note: This test is available only when the GPS module is present.

3.4 MEMORY

Delivers the information about the mobile computer's memory. It also initializes the memory.

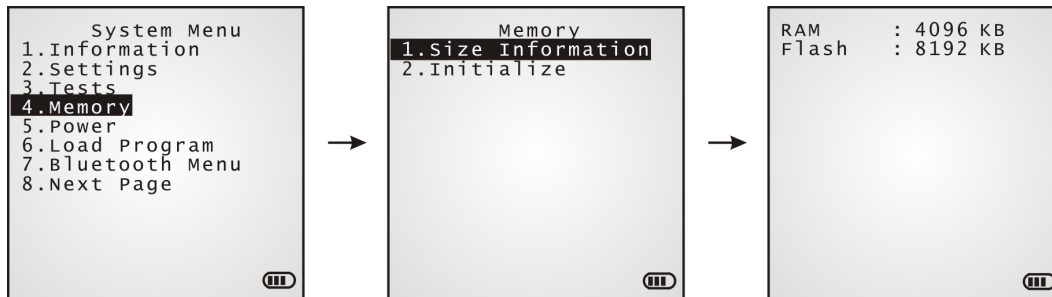

3.4.1 SIZE INFORMATION

Delivers an overview of memory information:

- ▶ RAM — onboard SRAM for data memory
- ▶ Flash — program memory

3.4.2 INITIALIZE

Initializes the data memory.

Warning! The contents of the data memory (SRAM) will be wiped out after memory initialization.

3.5 POWER

Delivers the mobile computer's current voltage consumption.

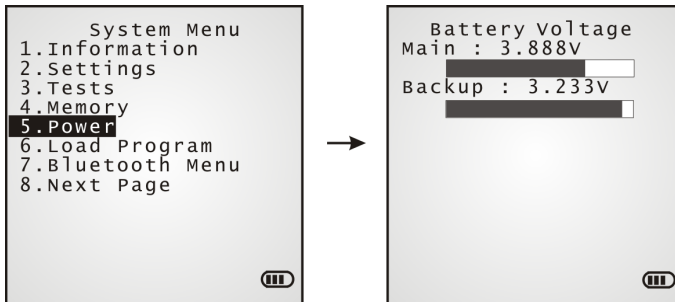

Main (battery)

Shows the dynamic status of the battery pack, which is the main power source.

Backup (battery)

Shows the dynamic status of the button cell, which supplies power to retain data in SRAM.

Warning! Always examine the battery icon on the device screen so you will be alerted for a low battery condition.

3.6 LOAD PROGRAM

Launches the mobile computer's Load Program service provided by the kernel. After a program is downloaded to the mobile computer, you won't be able to return to **System Menu** by pressing [ESC] as the kernel will take over the job. In this case, restart the mobile computer to activate the new program. Refer to [Appendix I Download Utility](#).

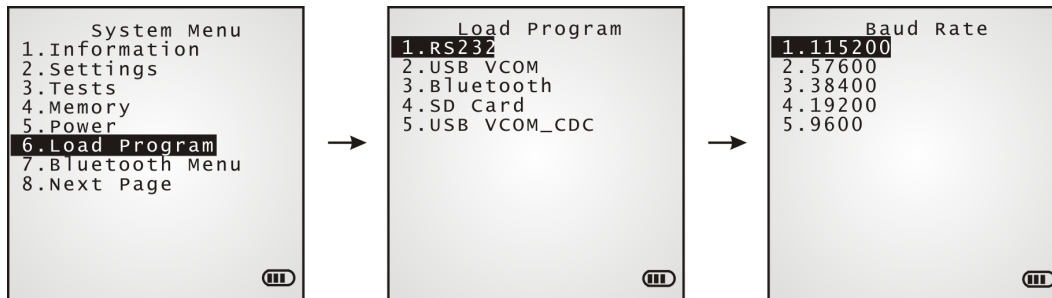

Note: When RS-232 is selected for the transmission interface, the mobile computer stays in download mode for about 30 seconds only. The preparation (such as connecting the RS-232 cable) and the kernel update should be done before the download mode expires.

The following files are downloadable by Load Program command:

.SHX Program	Downloadable C program files and/or font file:
Program File	<ul style="list-style-type: none"> ▶ AG Runtime: U8700.shx (Batch AG) WU8700.shx (WLAN AG) ▶ CipherNet Runtime: 87xx-5250.shx (CipherNet-5250) 87xx-VT.shx (CipherNet-VT) ▶ BASIC Runtime^{Note}: B8700.shx ▶ User program
Font File	Refer to the Font Files folder on CD-ROM.

If you have downloaded a BASIC Runtime program, you will be able to select whether to download a C program (.SHX) or BASIC program (.SYN) the next time you access the Load Program command.

Note: (1) "Load Basic" menu is only available after you have downloaded a BASIC Runtime program.
(2) In addition to the system font, there can be only one more font file downloaded to the mobile computer.

SETTINGS
Interface

Options	Description
RS232	Loading programs from RS232-interfaced devices such as your PC. The mobile computer needs to connect to your PC with a RS232 cable. Baud rate settings are necessary on both your PC and the mobile computer.
USB VCOM	Loading programs from USB-interfaced devices such as Your PC. The mobile computer needs to connect to your PC with a USB cable.
Bluetooth	Loading programs from Bluetooth-enabled devices.
SD Card	Loading programs directly from the SD Card inserted in the mobile computer.
USB VCOM_CDC	Loading programs from USB-interfaced devices such as Your PC. The mobile computer needs to connect to your PC with a USB cable.

Baud Rate

Available baud rate options: 115200/57600/38400/19200/9600 bps

LOAD PROGRAM VIA BLUETOOTH

- 3) Go to **System Menu | 7. Bluetooth Menu | 3. Security**, and configure the following Bluetooth settings first.
 - ▶ Authentication
 - ▶ PIN code
- 4) Go to **System Menu | 6. Load Program** and select Bluetooth.
- 5) Have your PC initiate the pairing with the mobile computer by clicking [Pair Device] and/or [Connect Bluetooth Serial Port].
- 6) On your PC, run the download utility ProgLoad.exe. In [Comm setting] group box, make the following settings:
 - Select RS-232 for [Comm type], so as to access Bluetooth SPP.
 - Configure [COM port] properties according to the Bluetooth COM port generated on your PC. Go to **start | Control Panel | System | Hardware | COM & LPT** to check it up.

LOAD PROGRAM VIA SD CARD

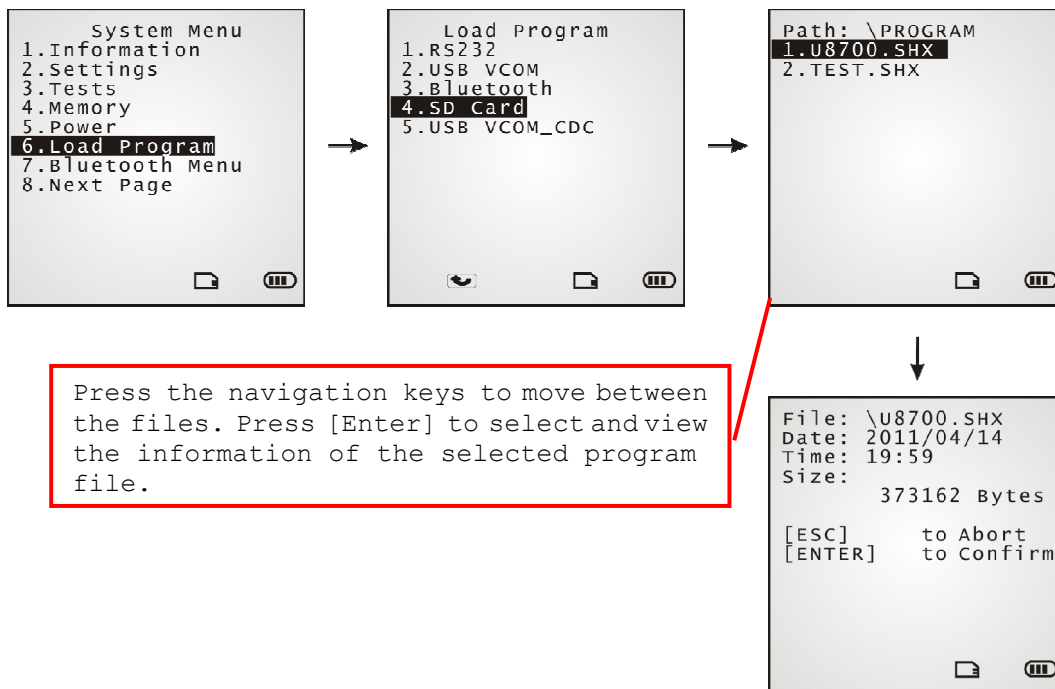

- 1) If you have copied the desired program file(s) to your SD card, go to **System Menu | 6. Load Program** and select SD Card. You will see a list of all the files under the directory "\Program", as shown above.
- 2) Press the navigation keys [Up] and [Down] to move between the listed files.
- 3) Press [Enter] to view information of the program file.
- 4) Press [Enter] to confirm downloading the program file to the mobile computer. Press [ESC] to abort the download task.

3.7 BLUETOOTH MENU

Sets the mobile computer to work with other Bluetooth devices. It takes correct settings to enable the Bluetooth communication.

Bluetooth Settings	Default Value	HID	SPP	DUN
Connect Setting		Items Need to Be Checked		
Local Name	Model no. + Serial no.	v	v	v
Remote Name	---	---	---	---
Broadcast Me	Enable	v	v	v
Power Saving	Enable	v	v	v
BT-GPRS AP Name	---	---	---	(v) ^{Note}
DHCP	Enable	---	---	(v) ^{Note}
Local IP Address	0.0.0.0	---	---	(v) ^{Note}
Security		Items Need to Be Checked		
Authentication	Disable	v	v	v
PIN Code	---	v	v	v

Note: BT-GPRS AP Name, DHCP and local IP Address are required for DUN-GPRS mode only.

3.7.1 INFORMATION

Delivers the mobile computer's Bluetooth network configuration.

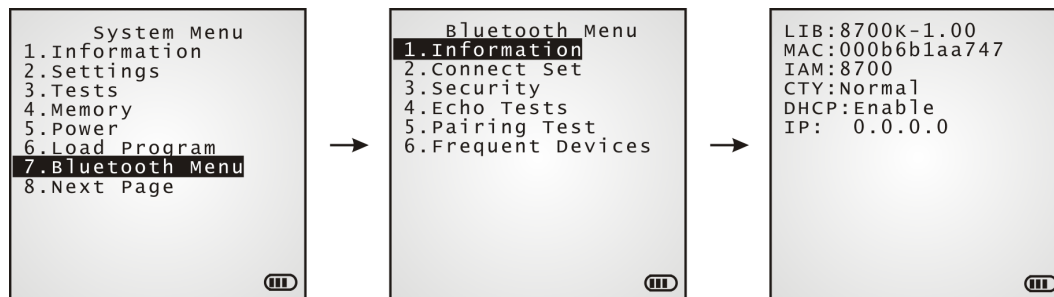

Bluetooth Menu | 1. Information

LIB	Kernel version
MAC	MAC address of the Bluetooth module
IAM	A name given to the mobile computer for identification <ul style="list-style-type: none"> ▶ By default, it is comprised of the model number and the serial number. (Identical to Bluetooth Menu 2. Connect Set 1. Local Name)

- CTY** "Normal" means all 79 channels are available for frequency-hopping.
- ▶ There are bandwidth limitations for 2.4 GHz ISM band in some countries. For example, only 23 RF channels are defined instead of 79 RF channels in Japan, Spain and France.
- DHCP** DHCP server in use or not
- ▶ It will automatically become enabled while connecting to a BT-GPRS AP.
- IP** IP address of the mobile computer

3.7.2 CONNECT SETTING

Sets the necessary parameters for mobile computer's Bluetooth networking.

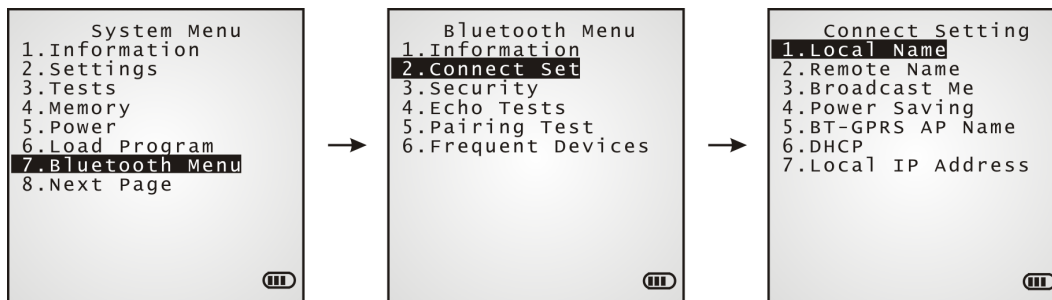

Local Name

Enter a name for identifying the mobile computer.

- ▶ By default, it is comprised of the model number and the serial number.

Remote Name

Leave it empty unless you want to make a specific connection.

Broadcast Me

Options — Enable or Disable

- ▶ For initial connection, broadcasting must be enabled so other Bluetooth devices can discover the mobile computer.
- ▶ For security concerns, you may disable it in future use to hide the mobile computer from other Bluetooth devices.

Power Saving

Sets the mobile computer to the low power consumption mode.

Options — Enable or Disable (Only the Sniff mode is supported.)

BT-GPRS AP Name

For DUN-GPRS mode, enter the AP name for connecting to the content server.

DHCP

Options - Enable or Disable

Local IP Address

Enter a new address for the mobile computer, if necessary.

Note: BT-GPRS AP Name, DHCP and local IP Address are required for DUN-GPRS mode only.

3.7.3 SECURITY

Sets or modifies the security parameters for the mobile computer's Bluetooth connection.

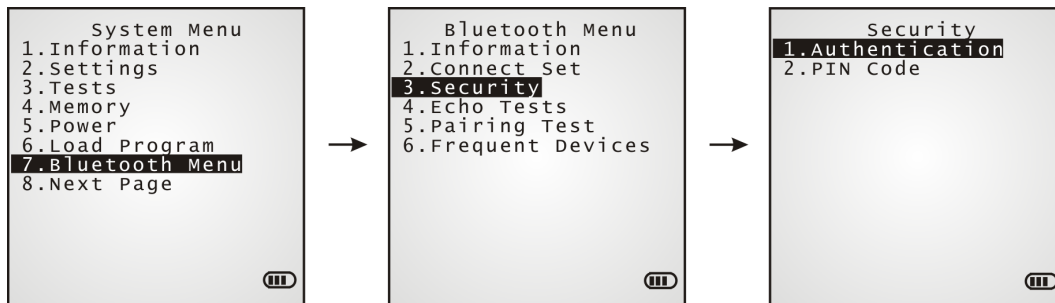

Authentication

Such "Authentication" concerns the pre-pairing validation between two Bluetooth devices before they can communicate with each other. Options available are Enable and Disable.

PIN Code

Enter a "Pin Code" to function for the encryption key value. Pairing is only achievable when two Bluetooth devices present the same Pin Code.

- ▶ Up to 16 characters, in ASCII format.

Note: When authentication is enabled without providing a pre-set PIN code, the mobile computer supports dynamic input of PIN code during pairing.

3.7.4 ECHO TESTS

Launches the echo tests that verify the mobile computer's Bluetooth connectivity to make sure it sits within the wireless transmission range. Press [ESC] to stop and quit the test.

Some key terms addressed in the submenu are defined as follows:

- ▶ SPP: Serial Port Profile
Bluetooth SPP is for Bluetooth-enabled devices such as the mobile computer to wirelessly connect to an ad hoc network.
- ▶ DUN: Dial-Up Networking Profile
Bluetooth DUN is for Bluetooth-enabled devices such as the mobile computer to access the Internet and other dial-up services.

- DUN Modem – Select this command to have the mobile computer access a Bluetooth modem or mobile phone to use it as a wireless modem.
- DUN GPRS – Select this command to have the mobile computer access a GPRS-enabled mobile phone to connect to a GPRS AP.

▶ **HID:** Human Interface Device Profile

Bluetooth HID enables the mobile computer to function as an input device (such as a keyboard) for another Bluetooth enabled device such as your PC.

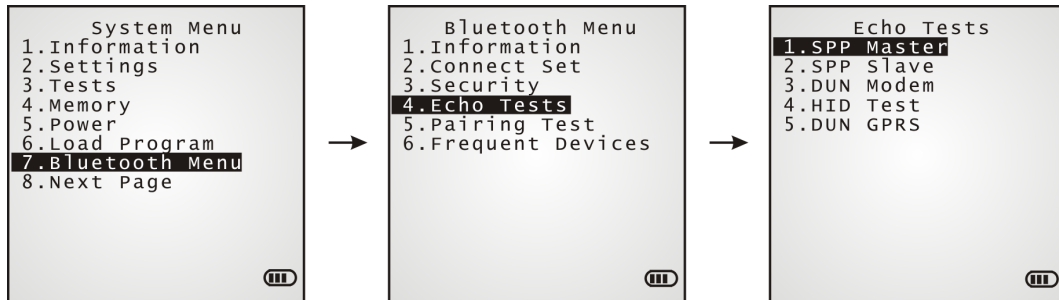

SPP Master

Sets the mobile computer as a master device.

1. Pairing with your PC (slave) must be completed first.
2. Run the utility "EchoTest.exe" on your PC. Associated settings include:
 - Select "RS-232" for interface.
 - Use the (incoming) Bluetooth COM port that has been paired.
 - Set Action Mode to "Passive".
3. Start the echo test on both sides. The mobile computer will try to connect to PC (slave).

SPP Slave

Sets the mobile computer as a slave device.

1. Enable Authentication and set PIN code on the mobile computer.
2. Run the utility "EchoTest.exe" on your PC. Associated settings include:
 - Select "RS-232" for interface.
 - Use the Bluetooth COM port that has been configured as "outgoing".
 - Set Action Mode to "Passive".
3. Start the echo test on both sides.
4. The mobile computer will wait for PC (master) to start the connection.
5. Enter the preset PIN code for authentication on your PC.

DUN Modem

Sets the mobile computer to connect to a Bluetooth modem or mobile phone.

1. Pairing with that mobile phone must be completed first.
Select "DialUp Network" for Target Machine options.
2. Run the utility "EchoTest.exe" on your PC. Associated settings include:
 - Select "Modem" for interface.
 - Set Action Mode to "Passive".
3. Start the echo test on both sides.
4. The mobile computer will connect to the mobile phone that dials up to your PC.

HID Test

Sets the mobile computer as an input device for another Bluetooth-enabled device.

1. Pair the mobile computer with another Bluetooth-enabled device (such as your PC) first
2. On the mobile computer, select **HID Test**. Configure keyboard type and upper/lower case mode when you are prompted to. Then the mobile computer enters HID test mode and tries to make up Bluetooth connection with your PC. As soon as the connection is reached, 8700 will display a ready message on the screen. (It is suggested to that you disable the Authentication on the mobile computer.)
3. On your PC, run a text editor.
4. You can proceed to input data via the mobile computer's keypad.

DUN GPRS

Sets the mobile computer to connect to a mobile phone with 3.5G functionality.

1. Pairing with that mobile phone must be completed first.

On the mobile computer, under when you are prompted to select the type of the target device, select "DialUp Network".
2. Under the mobile computer's **Echo Tests | 5. DUN GPRS** command, enter the IP and port number of the server.
3. Run the utility "EchoTest.exe" on your PC. Associated settings include:
 - Select "TCP/IP – Server" for interface.
 - Set Action Mode to "Passive".
4. Start the echo test on both sides.
5. The mobile computer will connect to the mobile phone that dials up a GPRS AP, and finally connect to your PC (server) through the GPRS AP.

3.7.5 PAIRING TEST

Launches the test if pairing is achieved between two Bluetooth-enabled devices. Pairing deals with the procedure whereby two Bluetooth-enabled devices accept each other's connection request by creating and exchanging a link key. Such link key remains efficacious for authentication when the two Bluetooth-enabled devices are exchanging information in the future

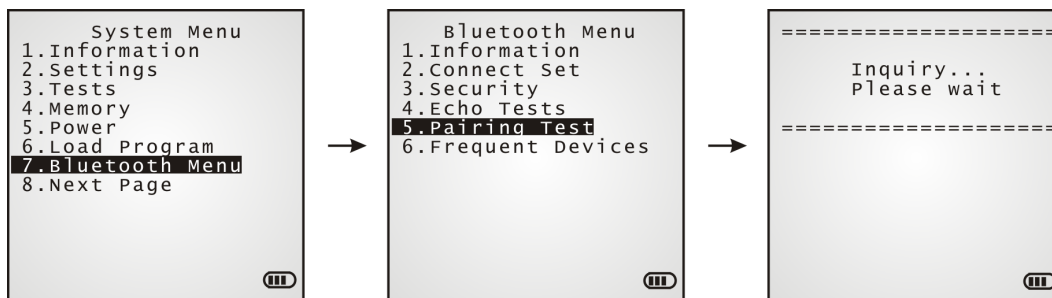

- 1) As soon as Pairing Test is selected, the mobile computer starts to inquire the discoverable Bluetooth device(s) nearby, and the system will generate a list of them.
- 2) Select a target device to test connection.

For the device name, it can only display a maximum length of 11 characters. When the device name is too long, it will be truncated automatically.
- 3) Select a Bluetooth service from the "Target Machine" menu. To stop and quit the test, press [ESC].

After pairing succeeds, the target device will be added to the Frequent Devices list for quick connection in the future.

Note: For the initial use of Bluetooth networking, the pairing procedure must be done before the Echo tests.

3.7.6 FREQUENT DEVICES

Lists the devices the mobile computer has recently Bluetooth-connected to. Such list gets updated each time pairing is achieved for the mobile computer with another Bluetooth device.

Listed are the connected devices with any of the following services:

- ▶ Serial Port (SPP)
- ▶ Dial-Up Networking (DUN)
- ▶ Human Interface Device (HID)

For the device name, maximum 11 characters are displayed. When the device name is longer, it is truncated automatically.

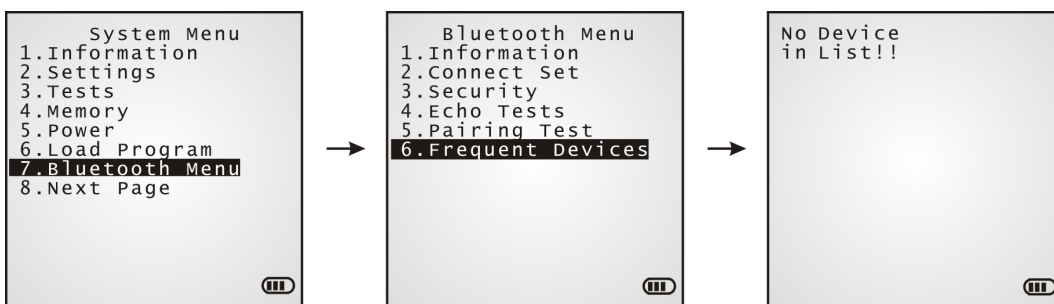

Note: To unpair any device, simply delete the device from this list.

3.8 SD CARD MENU

Sets the mobile computer to a removable disk when equipped with a SD card. The files on the SD card can be accessed directly.

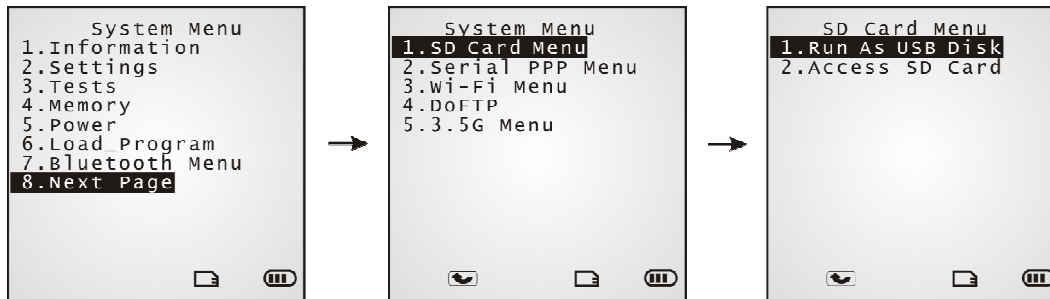

Note: (1) As soon as a SD card is installed in the mobile computer, the card icon appears at the bottom of the screen. When the SD card is accessed, such icon starts to blink.

(2) As long as the mobile computer is preinstalled with Batch AG runtime, it will automatically create two working directories “\AG\IMPORT” and “\AG\EXPORT” as soon as a SD card is inserted.

3.8.1 RUN AS USB DISK

When the mobile computer is equipped with a SD card and connected to your PC via a USB cable, it runs as a removable disk (USB mass storage device) as long as it is configured properly through programming or via your selection of [Run as USB Disk].

Note: The SD card must be properly configured through programming or the menu here.

3.8.2 ACCESS SD CARD

Edits the files on the SD card or formats the SD card.

Edit Files

Views and edits the files on the SD card.

Format

Formats the SD card and recreates file system.

If the current file system on the SD card isn't desired any more, you can format the SD card.

- ▶ If the capacity is 32 MB or less, the file system recreated will be FAT12.
- ▶ If the capacity is 32 MB~2 GB, the file system recreated will be FAT16.
- ▶ If the capacity is more than 2 GB, the file system recreated will be FAT32.

Warning! The contents on the SD card will be wiped out after formatting.

Check Memory

Checks the memory size of the SD card inserted.

- ▶ For an SD card that has never been used on the mobile computer, a message like "Found New SD Card" will display allowing users to scan the card for memory check. However you can select cancellation and run the memory check later.

Check File Size

Calibrates the size of the DAT files on the SD card when running BASIC application. This command also refreshes the size of "A:\BASICRUN\TXACTn.DAT" (n=1~6).

Note: "Check File Size" is only available after a BASIC Runtime program is downloaded to the mobile computer.

3.9 SERIAL PPP MENU

Enables the mobile computer to connect to a generic modem by serial PPP to access the Internet. The parameters must be correctly set to establish the connection.

- ▶ Point-to-Point Protocol (PPP) is a method of connecting the mobile computer to the Internet over serial links. It sends TCP/IP packets to a server that connects to the Internet.

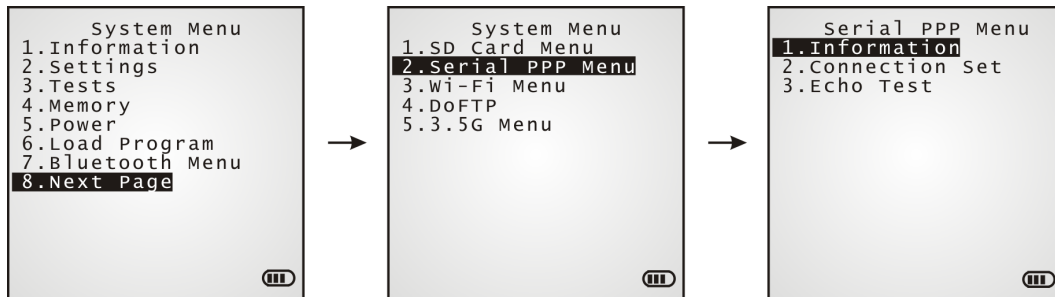

3.9.1 INFORMATION

Delivers the serial PPP library version.

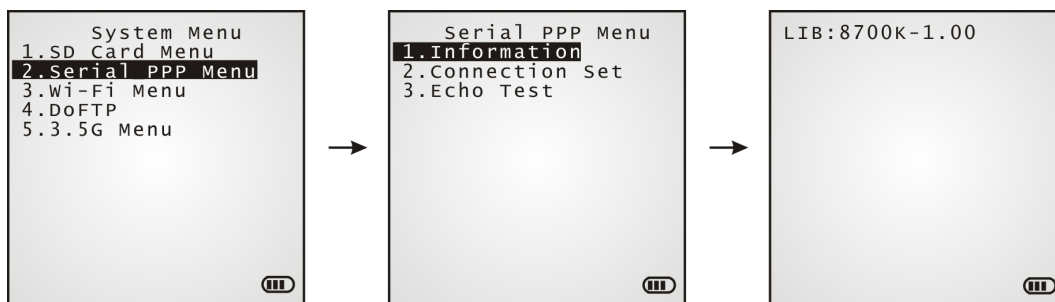

Serial PPP Menu | 1. Information

LIB Kernel version

- ▶ All user libraries reside in Kernel; no external libraries are required.

3.9.2 CONNECTION SET

Sets the mobile computer's serial PPP connection to a generic modem.

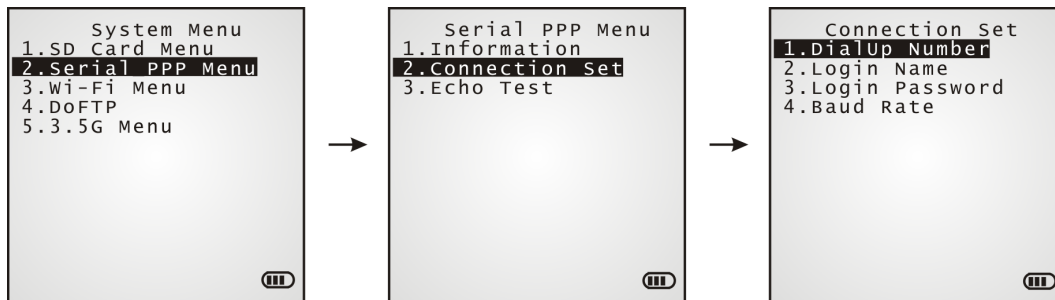

DialUp Number

Enter the number provided by your ISP.

Login Name

Enter the login name provided by your ISP.

Login Password

Enter the login password provided by your ISP.

Baud Rate

Select a desired baud rate.

3.9.3 ECHO TEST

Launches the echo tests that verify the mobile computer's connectivity through Point-to-Point Protocol.

Connect the mobile computer to a generic modem and start the test.

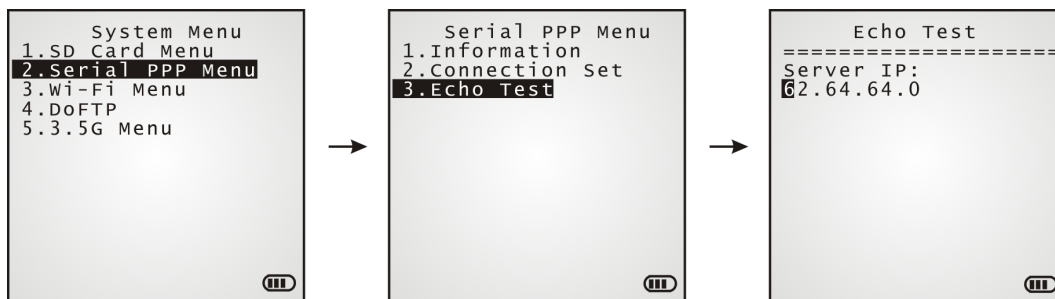

Note: In Server IP field, enter the IP address of the server to be connected via PPP protocol. The mobile computer will try to connect to the server. After the PPP connection is established, run the utility "EchoTest.exe" on your PC. In the control panel of EchoTest.exe, set the communication port to "TCP/IP-Server". Start the test on the mobile computer.

3.10 WI-FI MENU

Sets the mobile computer's 802.11b/g connection.

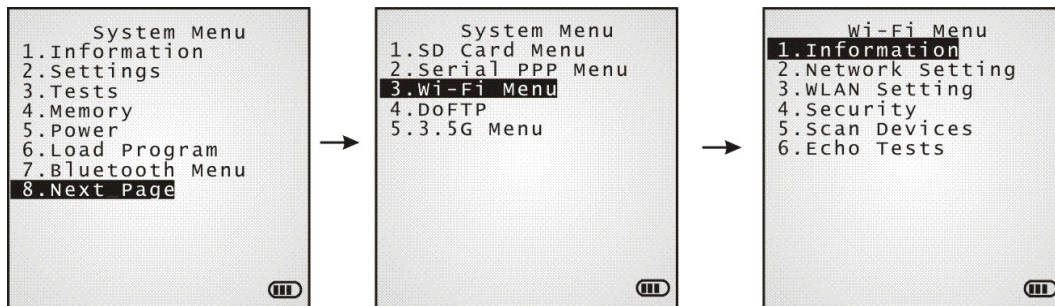

Note: This menu item is available only when the Wi-Fi module is present.

Wi-Fi Settings	Default Value	Ad-hoc	Infrastructure
Network Setting		Items Need to Be Checked	
DHCP	Enabled	---	v
SubNet Mask	255.255.128.0	v	v
Local IP Address	0.0.0.0	v	v
Default Gateway	0.0.0.0	---	v
DNS Server	0.0.0.0	---	v
Domain Name	---	---	v
WLAN Setting			
Local Name	Model no. + Serial no.	v	v
SS ID	---	---	v
System Scale	Medium	---	v
Power Saving	Enabled	---	v
Preamble	Long	---	v
Ad-Hoc	Disabled	v	---
Fixed BSSID	000000000000	---	v
Security			
Authentication	Open System	---	v
WEP Menu	Disabled	---	v
EAP Menu	Disabled	---	v
WPA Menu	Disabled	---	v

3.10.1 INFORMATION

Delivers the mobile computer's Wi-Fi networking configuration.

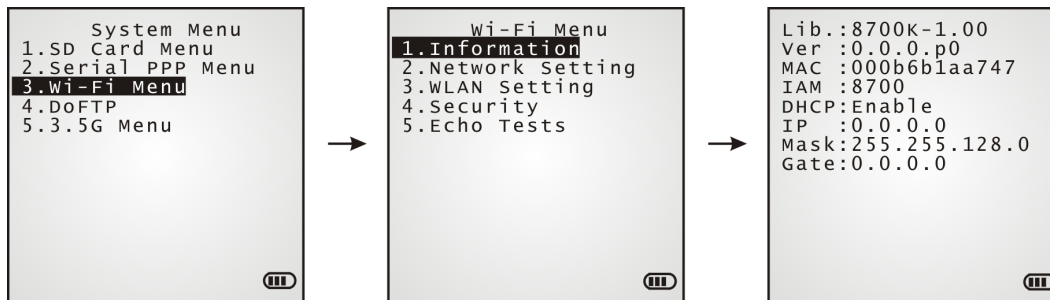

Wi-Fi Menu | 1. Information

Lib	Kernel version <ul style="list-style-type: none"> ▶ All user libraries reside in Kernel; no external libraries are required.
Ver	Firmware version of the Wi-Fi module
MAC	MAC address of the Wi-Fi module
IAM	A name given to the mobile computer for identification. <ul style="list-style-type: none"> ▶ By default, it is comprised of model number and the serial number. (Identical to 3. WLAN Setting 1. Local Name)
DHCP	DHCP server in use or not
IP	IP address of the mobile computer
Mask	Subnet Mask
Gate	Default Gateway

3.10.2 NETWORK SETTING

Sets the mobile computer's Wi-Fi networking parameters.

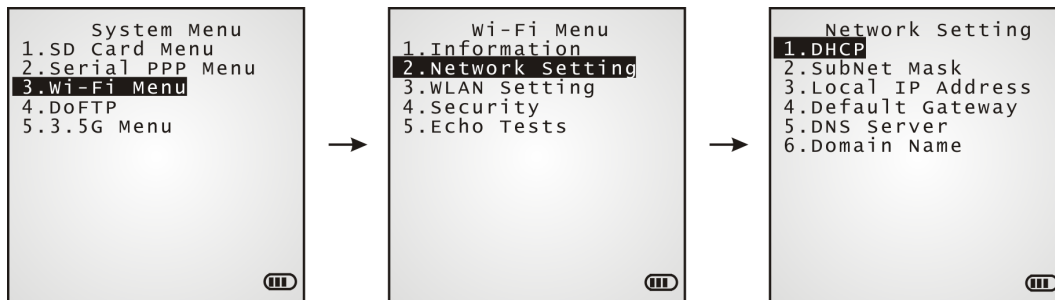

DHCP

Options — Enable or Disable

Subnet Mask

Enter a new Mask IP, if necessary.

Local IP Address

Enter a new address for the mobile computer, if necessary.

Default Gateway

Enter a new address for the default Gateway, if necessary.

DNS Server

Enter a new address for the DNS server, if necessary.

Domain Name

When DHCP server is enabled, the domain name of the host displays in this field.

Note: Normally, DHCP is enabled by default, and all related settings can be obtained from the DHCP server.

3.10.3 WLAN SETTING

Sets the mobile computer's Wi-Fi connection that works in either mode – (1) Ad-hoc mode: peer-to-peer, or (2) Infrastructure mode: point to multi-point through access points.

Set the following parameters:

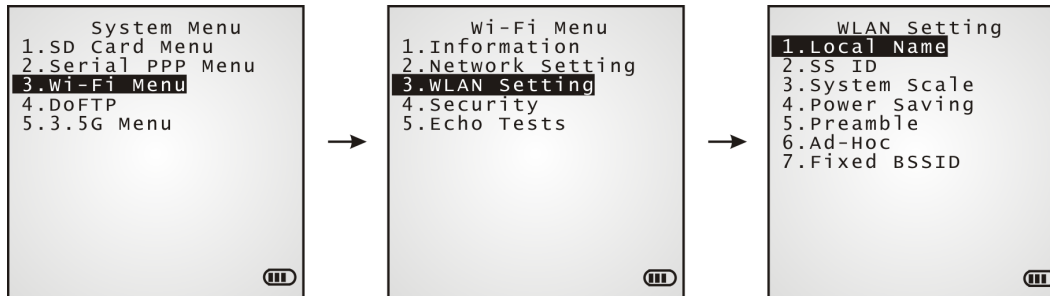

Local Name

Enter a name for identifying the mobile computer.

- ▶ By default, the name is comprised of the model number and the serial number.

SS ID

"SS ID" means "Service Set Identifier". It could be the name of the AP for remote device association.

- ▶ As long as an SS ID is set, the mobile computer can ONLY communicate with the devices of the same SS ID.

System Scale

This refers to Access Point density.

Options — [1] Low [2] Medium [3] High [4] Customized

- ▶ The setting must be consistent with that of the access point.
- ▶ Set to "Low", "Medium", or "High" to have the mobile computer scan for other access points when data transmission rate drops below "1", "2" or "5" Mbps respectively.
- ▶ Set to "Customized" to have the mobile computer scan for other access points when the data transmission rate drops below the following configurable values —
802.11b: 1, 2, 5.5, 11 Mbps
802.11g: 1, 2, 5.5, 11 Mbps & 6, 9, 12, 18, 24, 36, 48, 54 Mbps

Power Saving

This refers to the low power consumption mode.

Options — Enable or Disable

- ▶ The setting must be consistent with that of the access point.

Preamble

Options — [1] Long [2] Short [3] Both

- ▶ The setting must be consistent with that of the access point.

Ad-Hoc

This refers to peer-to-peer mode, without going through access points.

Options — Enable or Disable

Fixed BSSID

This refers to the use of a specific AP's MAC address as the fixed Basic Service Set Identifier.

- ▶ When a Fixed BSSID is set, the mobile computer can ONLY communicate with the one and only access point.

3.10.4 SECURITY

Sets or modifies the security parameters for the mobile computer's Wi-Fi connections.

- ▶ WEP: Wired Equivalent Privacy
- ▶ EAP: Extensible Authentication Protocol
- ▶ WPA: Wi-Fi Protected Access

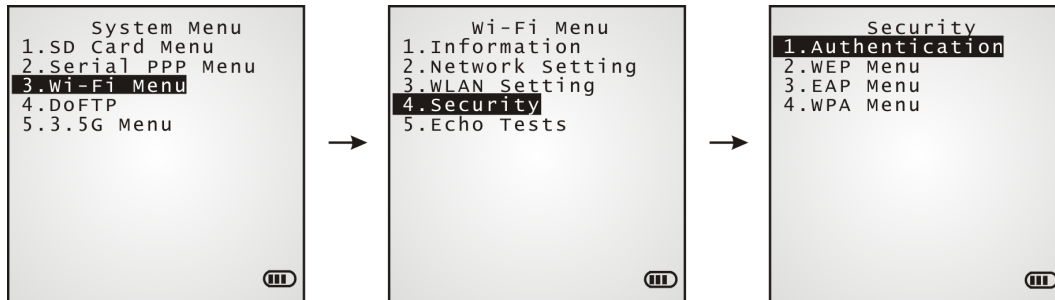

Authentication

- [1] Open System
 - ▶ "Open System" is the default. Where it is set to "Open System", there is no authentication.
- [0] Share Key
 - ▶ If it is set to "Share Key", a WEP key needs to be set up. See **WEP Menu** in the following for details.

WEP Menu

- WEP Setting
 - ▶ Enabled (It must be enabled if you will opt or have opted for a "Share Key" for authentication.)
 - ▶ Disabled (default)
- WEP Key Length
 - ▶ 64 bits
 - ▶ 128 bits (default)
- Default Key

As the mobile computer can store up to four WEP Keys, you can configure one WEP key to take force here in this submenu. If you don't assign one, WEP KEY1 will be the default.
- WEP Key

This submenu enables the configuration of WEP Keys 1 to 4 in either of the following format:

 - ▶ ASCII (up to 13 characters)
 - ▶ Hexadecimal (up to 26 characters)

EAP Menu (for associating to Cisco access points)

- EAP Setting
 - ▶ Enabled
 - ▶ Disabled (default)
- EAP ID

Enter a user name (up to 32 characters)
- EAP Password

Enter a password (up to 32 characters)

WPA Menu (WPA-PSK)

- WPA Setting
 - ▶ Enabled
 - ▶ Disable (default)

- WPA2 Setting ▶ Enable
 ▶ Disable (default)
- WPA Passphrase Enter a phrase as your password (8 ~ 63 characters)

3.10.5 ECHO TESTS

Launches the echo tests that verify if the mobile computer sits within the coverage of a WLAN. It also helps estimate the number of APs and mobile computers needed, and helps with the topology of APs deployment.

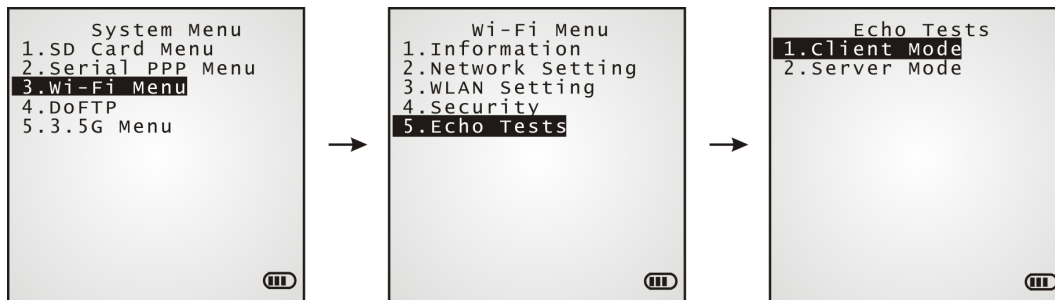

Client Mode

Select this item to set the mobile computer as a client. Enter the IP address of the server to connect to. The mobile computer will proceed to connect to an AP.

1. Enter the server IP and server port number on the mobile computer.
2. Run the utility "EchoTest.exe" on your PC. Associated settings include the following:
 - Select "TCP/IP – Server" for interface.
 - Set Action Mode to "Passive".
3. Start the echo test on both sides.

Server Mode

Select this item to set the mobile computer as a server. The mobile computer will proceed to connect to an AP.

1. Run the utility "EchoTest.exe" on your PC. Associated settings include the following:
 - Select "TCP/IP – Client" for interface.
 - Set Action Mode to "Passive".
2. Start the echo test on both sides.

While running echo tests, if WPA setting is enabled for security, the SSID and Passphrase will be processed to generate a pre-share key.

Note: Once the SSID or Passphrase is changed, the pre-share key will be regenerated.

- 1) If the mobile computer is associating with an access point for the first time, there will be an antenna icon developing on the screen to indicate that the mobile computer is processing a pre-share key.
- 2) After a pre-share key is generated, the mobile computer proceeds to establish a connection with the access point, and you will see the whole antenna flashing.
- 3) As soon as the connection is successfully made between the mobile computer and the access point, you will see the whole antenna with the indication of wireless signal strength.

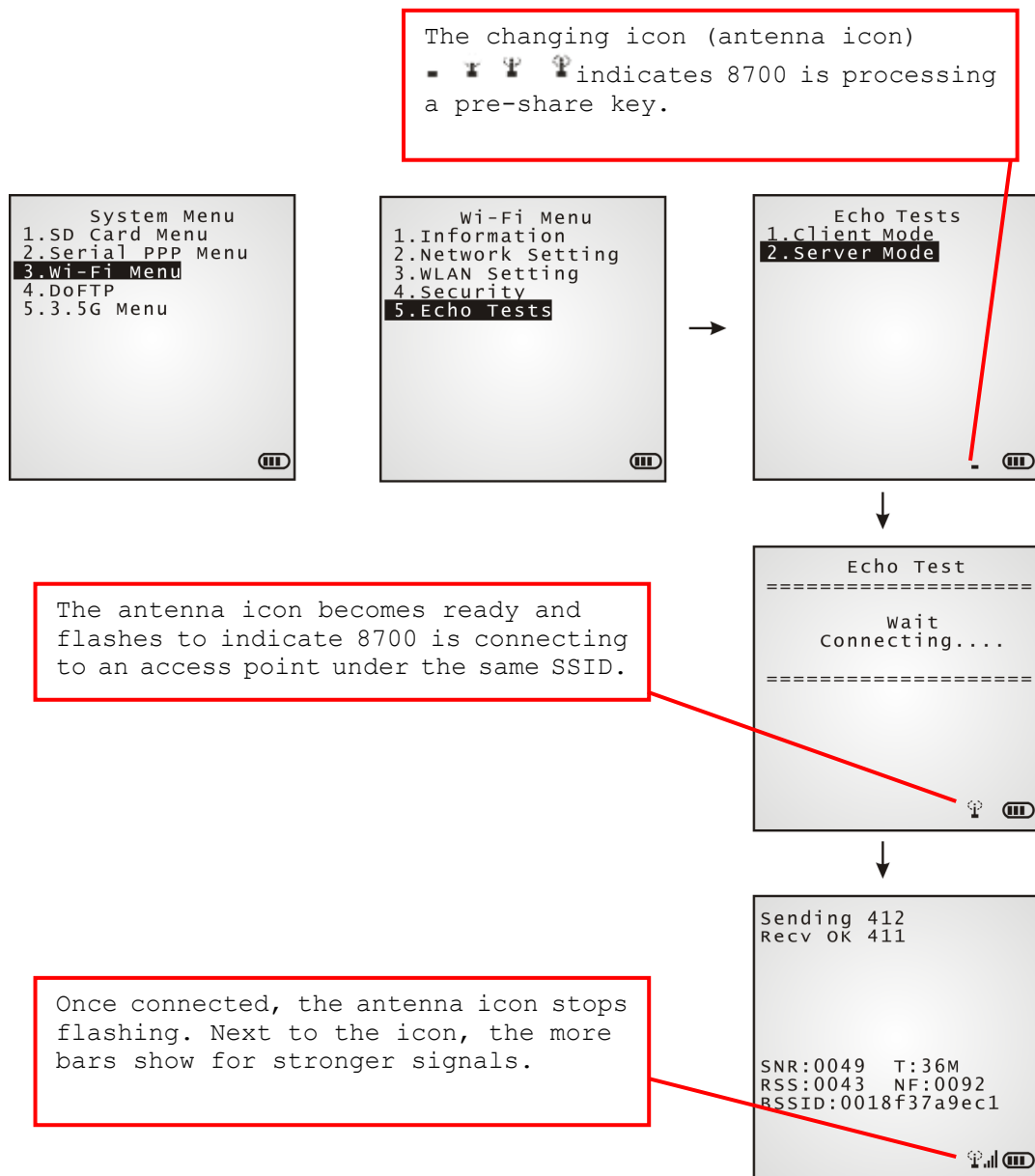

Note: If you are programming in C or BASIC, note the antenna icon will appear on the screen after NetInit() or START TCPIP() is called. (WPA must be enabled first!)

When the echo test is ongoing, the details display as illustrated below.

```

Sending 412
Recv OK 411

SNR:0049 T:36M
RSS:0043 NF:0092
BSSID:0018f37a9ec1

```



SNR (dB)	T	RSS (-dBm)	NF (-dBm)
(Signal to Noise ratio)	(Transmit Speed)	(Received Signal Strength Level)	(Noise Floor Level)
0 ~ 10	Very Poor	1 Mbps	0 ~ 92 Strong
10 ~ 20	Poor	2 Mbps	92 ~ 98 Moderate
20 ~ 30	Fair	5.5 Mbps	over 98 Weak
30 ~ 40	Good	11 Mbps	
over 40	Very Good	6 Mbps	
		9 Mbps	
		12 Mbps	
		18 Mbps	
		24 Mbps	
		36 Mbps	
		48 Mbps	
		54 Mbps	

3.11 DOFTP MENU

Sets the mobile computer to log into an FTP server via Wi-Fi for the following tasks:

- ▶ Execute and/or update "FTP.dat", a script file that keeps the history of the mobile computer's program updates.
- ▶ Download program update(s)

Note: Go to **System Menu** and configure the network settings first. Refer to [3.10 Wi-Fi Menu](#).

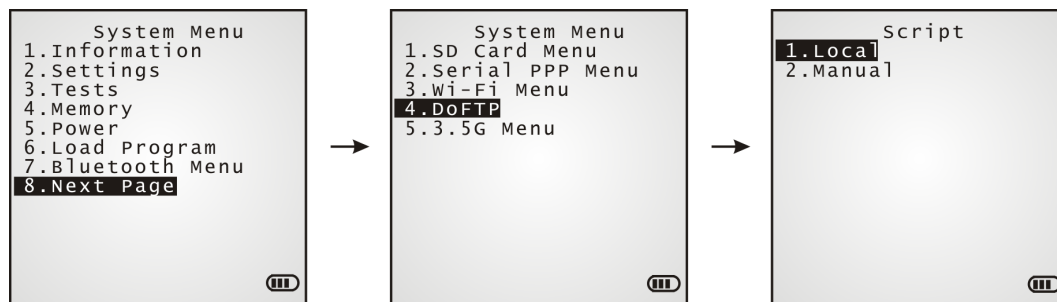

.SHX Program

Program File

Download one of the following C program files and/or font file, firmware file:

- ▶ AG Runtime: U8700.shx (Batch AG)
WU8700.shx (WLAN AG)
- ▶ CipherNet Runtime: 87xx-5250.shx (CipherNet-5250)
87xx-VT.shx (CipherNet-VT)
- ▶ BASIC Runtime: B8700.shx
- ▶ User program

Font File

Refer to the Font Files folder on CD-ROM.

Firmware File

- ▶ Kernel update: K8700.shx
- ▶ Bootloader update: BL8700.shx

Note: (1) When more than one program files of the same type are specified in the script file, only the last program file is used for update.

(2) The system will restart itself right after successful update and the downloaded file(s) will then be removed.

3.11.1 LOCAL

Sets the mobile computer to download program update or updates the script file "FTP.dat" according to the "FTP.dat" saved in the local storage of mobile computer.

Be sure to connect the mobile computer to a preset access point via Wi-Fi first.

3.11.2 MANUAL

Sets the mobile computer to update programs according to the remote script file "FTP.dat" on the FTP server the mobile computer connects to. Note such script file won't be kept after the updating act, and it won't replace the file saved on the mobile computer, if there is any.

SETTINGS

Server IP

Specify the IP address or name of the FTP server.

Server Port

Specify the remote FTP server port.

- ▶ By default, TCP port 21 is used on the server for the control connection.

Login Name

Specify the user name for logging onto the FTP server.

Login Password

Specify the password for logging onto the FTP server.

Interface

Connect the mobile computer to a preset access point via Wi-Fi.

3.12 3.5G MENU

Sets the mobile computer's HSDPA networking. The information required must be obtained from your 3.5G network operator.

HSDPA service can be summarized as follows:

- ▶ Receiving and sending data, including SMS (Short Message Service) and data call.
- ▶ By HSDPA, the mobile computer can establish a connection with a remote content server that connects to the Internet. Only client-initiated connection is supported.

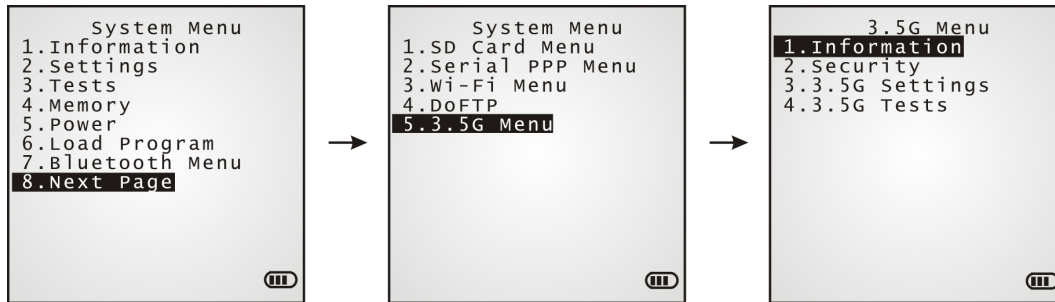

Note: The menu item is available only when the 3.5G module is present.

3.12.1 INFORMATION

Select this command to view the information of 3.5G network configuration.

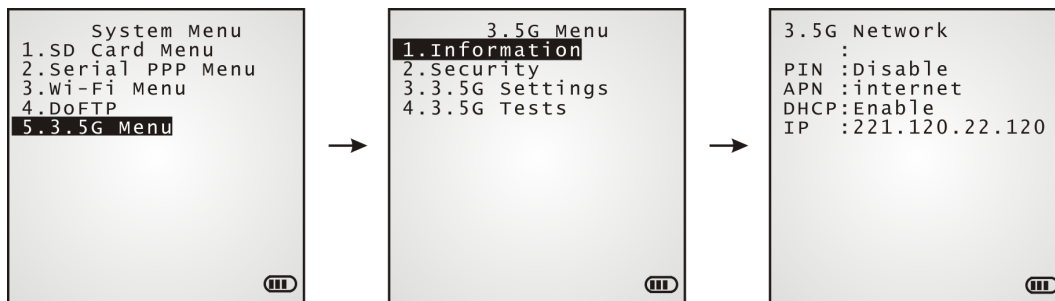

3.5G Menu | 1. Information

3.5G Network	Identification of 3.5G network operator
PIN	Personal Identity Number of SIM card for security check
APN	Access Point Name of your 3.5G operator
DHCP	DHCP server in use or not
IP	IP address of the mobile computer

3.12.2 SECURITY

Sets up the security check for the SIM card inserted in the mobile computer. With the submenu featured, you can set up a PIN code for authenticating the access to the SIM card. You can also change the PIN code if necessary.

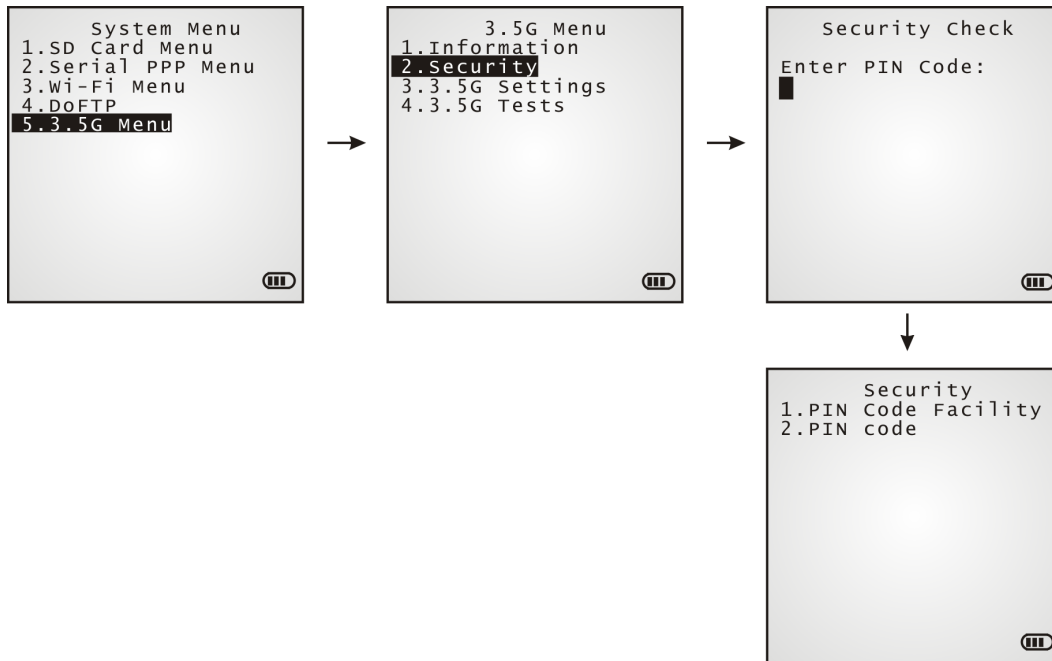

PIN Code Facility

- ▶ Enabled (PIN Code check)
- ▶ Disabled (default)

PIN Code

Change the SIM card's PIN code.

3.12.3 3.5G SETTING

Sets the mobile computer to access 3.5G mobile network.

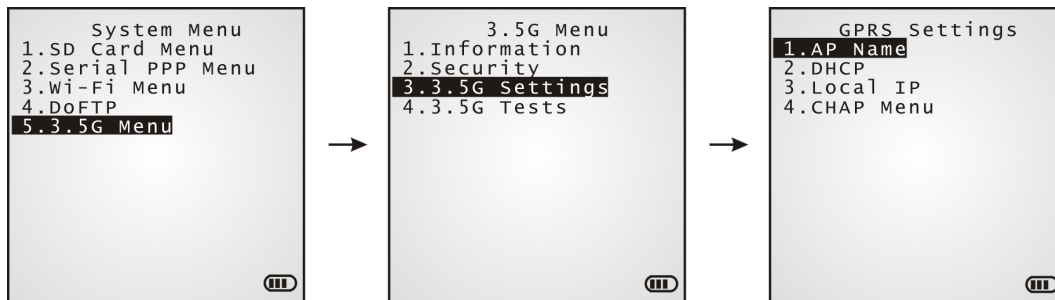

AP Name

Enter the AP name of your 3.5G operator.

DHCP

Options – Enable (default) or Disable

Local IP

Enter a new address for the mobile computer, if necessary.

CHAP Menu

- ▶ “CHAP” is the acronym of “Challenge Handshake Authentication Protocol”. It deals with an authentication measure used by Point to Point Protocol (PPP) servers to validate the identity of remote clients.

Setting	▶ Enable
	▶ Disable (default)
User Name	Enter a user name (up to 32 characters)
Password	Enter a password (up to 32 characters)

3.12.4 3.5G TESTS

This submenu provides the test for mobile computer to access the Short Message Service provided by the mobile network operator and also the tests on the mobile computer's connectivity to a 3.5G wireless modem and HSDPA AP.

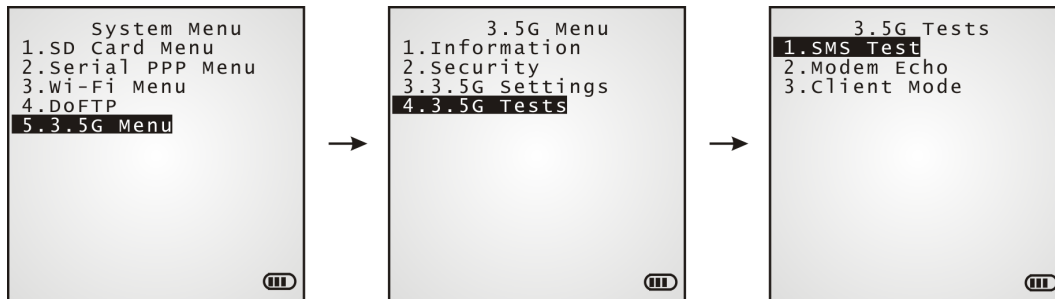

SMS Test

Select this command to send out a test message to verify the SMS. Enter a called number when you are prompted to.

Modem Echo

Select this command to have the mobile computer test-connect to a 3.5G modem.

1. On your PC, run the utility "EchoTest.exe". Associated settings include:
Select "Modem" for the communication interface.
Set Action Mode to "Passive".
2. On the mobile computer, enter the mobile number of the modem to be called in the **Dial Out Setting** field.
3. Start the echo test on both sides.
4. The mobile computer will proceed to connect to the 3.5G modem that dial-up connects to your PC.

Client Mode

Select this to have the mobile computer to connect to the HSDPA AP.

1. On your PC, run the utility "EchoTest.exe". Associated settings include:
Select "TCP/IP – Server" for the communication interface.
Set Action Mode to "Passive".
2. On the mobile computer, enter the server IP and server port number when you are prompted to.
3. Start the echo test on both sides.
4. The mobile computer will proceed to dial-up connect to a HSDPA AP to connect to your PC (server) through the HSDPA AP.

Note: After the HSDPA connection is established properly, run the utility "EchoTest.exe" on your PC (TCP/IP – Server), and then, start this test on the mobile computer.

PROGRAM MANAGER & KERNEL

This chapter will give you an account of the mobile computer's **Program Manager** and **Kernel** that manage multiple programs and firmware upgrade.

IN THIS CHAPTER

4.1 Program Manager	87
4.2 Kernel	92

4.1 PROGRAM MANAGER

The mobile computer supports multiple applications and languages. By the menu of **Program Manager**, the mobile computer allows storing up to six programs plus an activated one currently in use.

If there is no application program stored in the mobile computer, the **Program Manager** will display on the screen when the mobile computer is powered on.

Warning! **Program Manager** is provided for the program management in an administrative level. Non-administrative access to this menu should be properly warded off.

To access Program Manager:

- 1) Turn off the mobile computer.
- 2) Press [8] + [Power] simultaneously.

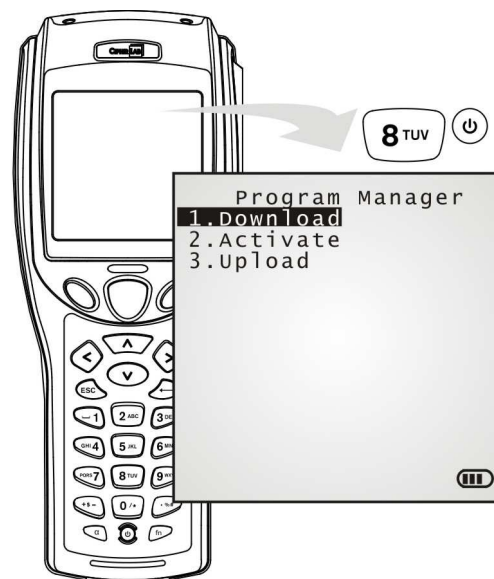

4.1.1 DOWNLOAD

Select this item to load programs for the mobile computer. When this item is selected, it first lists the programs currently stored on the mobile computer with size information.

The program name allows up to 12 characters while program size is reflected in kilobytes. Multiple application programs are downloadable to the mobile computer through a variety of interfaces. When downloading finishes, you are prompted to input a new name for that program. If there is no need to rename it, simply press [Enter] to leave the name unchanged and quit the rename field.

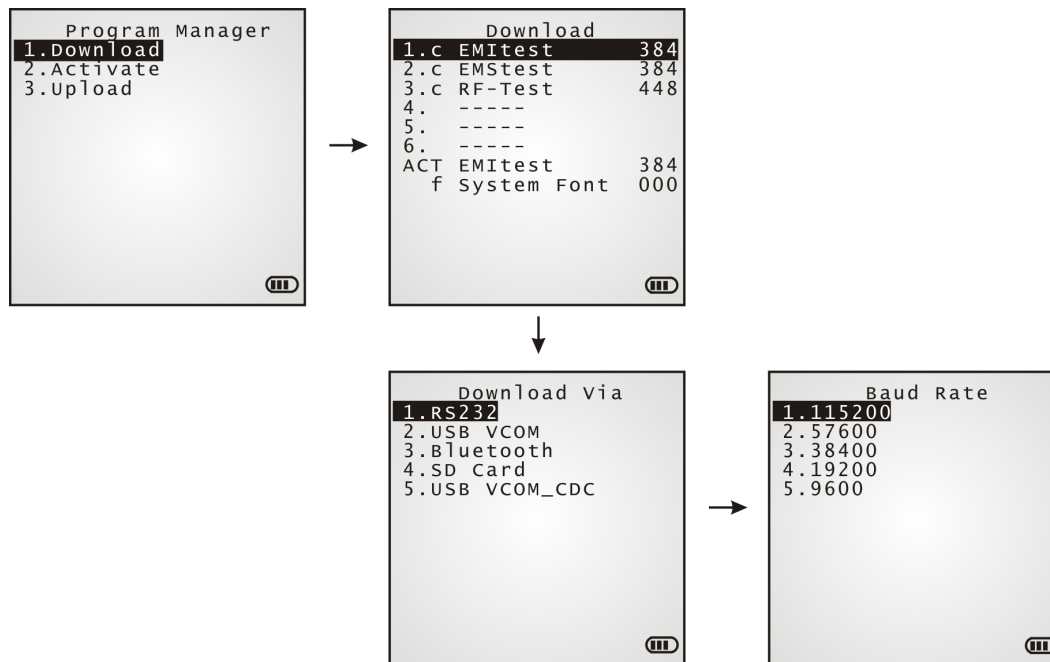

Each entry listed in the **Download** submenu represents a program that has been downloaded to the mobile computer. An entry is comprised of three elements: (1) The numbering, (2) the file name, and (3) the file size. They are detailed as follows:

- ▶ The numberings from 1 to 6:

Among the numberings from 1 to 6, each represents a memory sector available on the mobile computer for a program to occupy. When a program is downloaded to occupy a memory sector, a suffix letter will display after the numbering of that memory sector to represent the file type of that program. There are two types of program:

 - "b" for BASIC program (.SYN)
 - "c" for C program (.SHX)
- ▶ The file name: The file name of the downloaded program displays here.
- ▶ The file size: The file size of the downloaded program displays here. It is given by kilobytes.

At the bottom of this **Download** submenu, there are two lines:

- ▶ The line starting with "ACT" indicates the program that is activated and in use on the mobile computer at the moment. This is the program that is executed when the mobile computer's system starts up.
- ▶ The line starting with the letter "f" is a reserved line to display the font file (.SHX) in use by the mobile computer at the moment.

Note: For a custom font file (.SHX) or a BASIC program (.SYN), it can only be downloaded via **System Menu | 6. Load Program**.

MEMORY SECTOR (1 ~ 6)

A vacant cell in **Download** submenu represents a memory sector that is available for a program to occupy.

Download a program file to an available memory sector:

1. Press the navigation keys [Up] and [Down] to move between the items. Press [Enter] to select one.
2. Select a desired interface for downloading.
3. Connect the interface cable if required.
4. On your PC, run the utility ProgLoad.exe. Make necessary configuration on its user's interface, select the program to download, and press OK button to proceed. The mobile computer will start to download the selected program.
5. To abort the action, press [ESC]. Then press [ESC] again to return to the submenu.

Download a program file to an occupied memory sector:

If no more memory sector is available, you have to remove a downloaded program to make storage space for the new one.

1. Press the navigation keys [Up] and [Down] to move between the downloaded programs. Press [Enter] to select one to remove.
2. The program information displays on the screen.
Press the modifier key [a] to switch to upper-case alphabetic input mode:
 - ▶ Press the capital letter [C] and follow the steps below to download a program file.
 - ▶ Press the capital letter [D] if you simply want to delete the program.
3. Select a desired interface for downloading.
4. Connect the interface cable if required.
5. On your PC, run the utility ProgLoad.exe. Make necessary configuration on its user's interface, select the program to download, and press OK button to proceed. The mobile computer will start to download the assigned program.
6. To abort the action, press [ESC]. Then press [ESC] again to return to the submenu.
From the menu, you'll see the program has been deleted but no new program is present (because you have canceled the download action).

ACTIVE STORAGE MEMORY SECTOR ("ACT")

Only the application program that needs to be activated immediately should be downloaded to this memory sector.

Download to Memory Sector "ACT":

1. Press the navigation key [Down] to move down to the active memory sector, "ACT", which may be unoccupied already. Press [Enter] to select it.
2. Select a desired interface for downloading.
3. Connect the interface cable if required.
4. On your PC, run the utility ProgLoad.exe. Make necessary configuration on its user's interface, select the program to download, and press OK button to proceed. The mobile computer will start to download the assigned program.

If the active memory sector has already been occupied by an application program, the newly downloaded program will overwrite the old one and come to activation immediately.

4.1.2 ACTIVATE

Select this item to activate a program on the mobile computer. When this item is selected, it first lists all the spare programs stored on the mobile computer that isn't active at the moment.

Select any one from the list (from 1 to 6) or select the SD card. The selected program will be copied to the active memory sector and replace the current one.

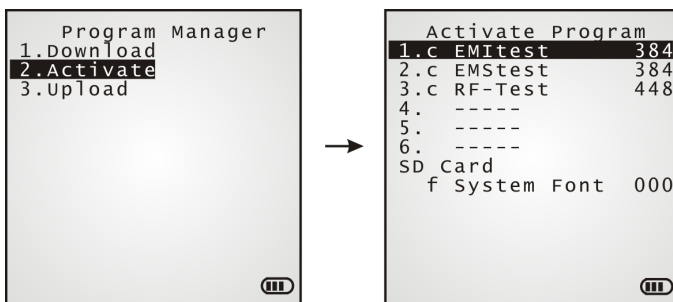

Note: A font file cannot be activated.

As soon as a program is activated, the mobile computer shuts down. When you power it on again, a screen appears showing the message <New Program Start>, take the following action to keep or clear out the files in the SRAM:

TO CLEAR FILE SYSTEM

Press [ESC] to clean out the files in the SRAM. In this case, no data (transactions, settings, etc.) is kept on the mobile computer when the new program comes into play.

TO KEEP FILE SYSTEM

To keep the files, simply press any key other than [ESC].

4.1.3 UPLOAD

Backs up any or all of the programs stored on the mobile computer to a host computer or another mobile computer. This is helpful for cloning software between multiple mobile computers.

Note: To clone all of the programs, the target mobile computer cannot have any other program downloaded except the active one, which means its memory sector 1 ~ 6 must be empty!

For the uploading procedures, please see those of downloading programs as they are similar.

- ▶ The transmission interfaces of "USB Virtual COM", "SD Card" and "USB Virtual COM_CDC" are not available when "Terminal" is selected for the Target Machine.
- ▶ The transmission interface "SD Card" isn't available when "PC" is selected for the Target Machine.

This screen is not available if you select "2.All Programs" from the previous screen.

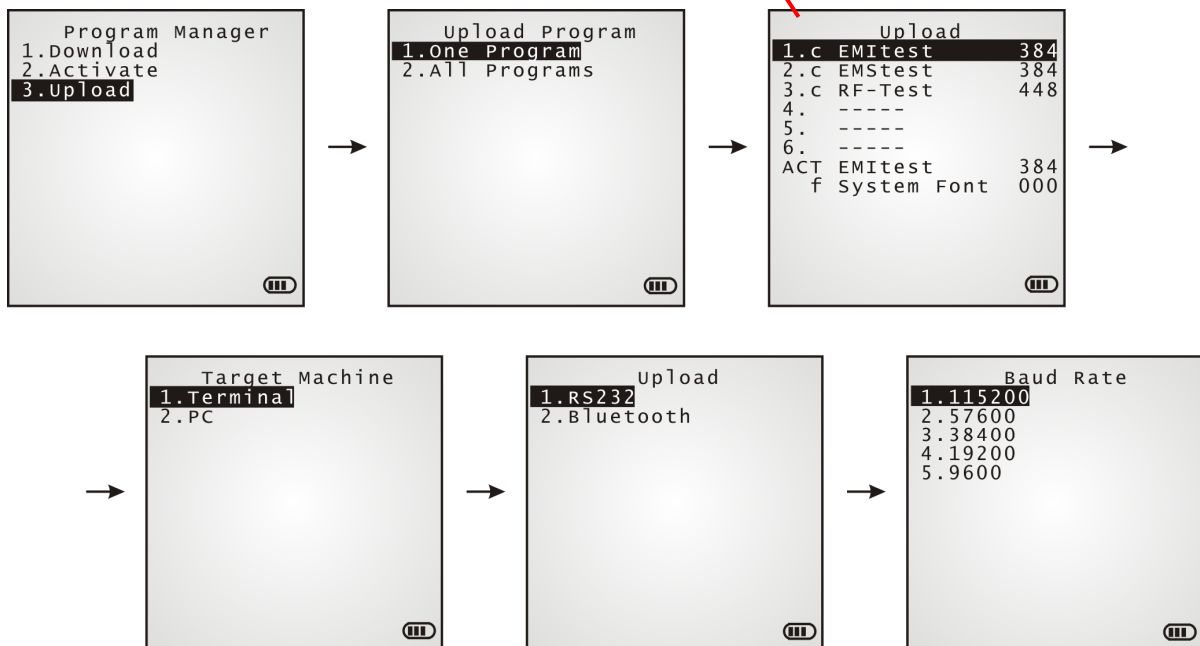

4.2 KERNEL

The kernel resides in the innermost core of the system. It has the highest security and is always protected by the system. When the application program is corrupted and **System Menu** fails at the same time, **Kernel Menu** provides an access to fix the system.

Warning! **Kernel Menu** is intended for the system management of administrator's level. Non-administrative access to this menu should be warded off.

To access Kernel Menu:

- 1) You need to power off the mobile computer first. When the last session is in **System Menu** or **Program Manager**, simply turn off the mobile computer; otherwise just reload the battery pack.
- 2) Press [1] + [7] + [Power] simultaneously.

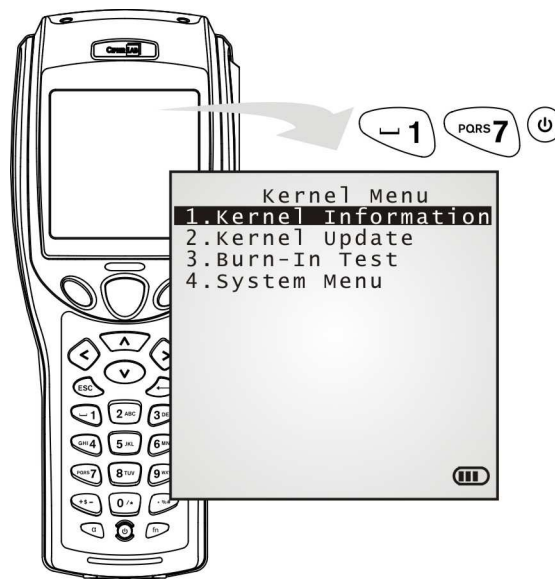

4.2.1 KERNEL INFORMATION

Delivers the important system information that helps diagnose the system.

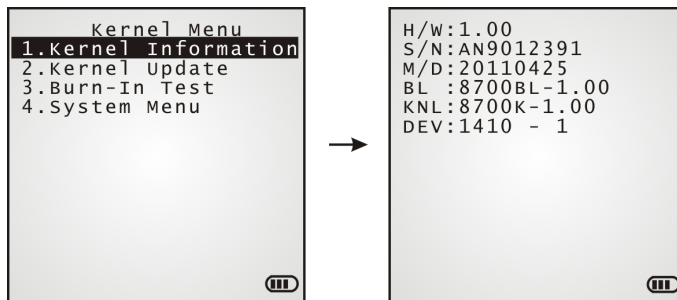

Kernel Menu | 1. Information

H/W	Hardware version
S/N	Serial number of the mobile computer
M/D	Manufacturing date
BL	Bootloader version
KNL	Kernel version
DEV	The 5-digit code stands for the combination of the hardware installed in the mobile computer. See the coding rule at 3.1.1 Understanding Device Code .

4.2.2 KERNEL UPDATE

Updates the kernel and bootloader. Such update may be necessary to improve system performance, or for the mercy of other considerations. Refer to [Appendix I Download Utility](#).

- ▶ To download a kernel (K8700.shx) or bootloader (BL8700.shx) update, the procedure is the same as that for downloading a program.
- ▶ Any attempt to download an older version of bootloader will be rejected.
- ▶ The system will restart itself right after downloading.

Warning: Whether during the downloading of kernel update or during the system re-start right after the kernel update, the mobile computer mustn't be powered off as it could lead to the permanent crash of the kernel.

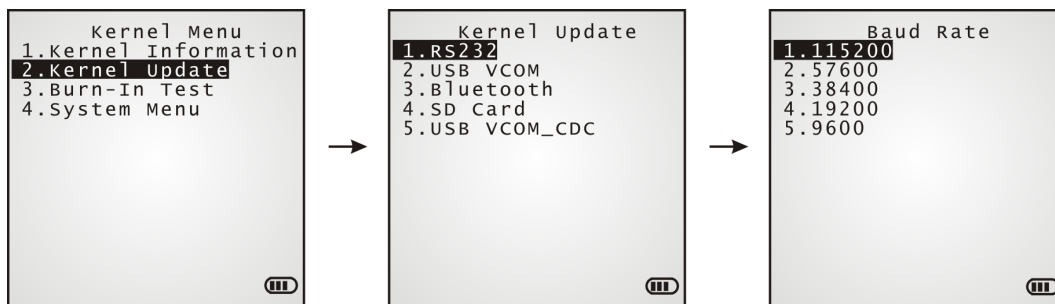

Note: When RS-232 is selected for the transmission interface, the mobile computer stays in download mode for about 30 seconds only. The preparation (such as connecting the RS-232 cable) and the kernel update should be done before the download mode expires.

Files downloadable through **Kernel Menu | 2. Kernel Update** are as listed below:

.SHX Program	Download one of the following firmware files:	
Firmware File	▶ Kernel update:	K8700.shx
	▶ Bootloader update:	BL8700.shx

SETTINGS

Interface

Options	Description
RS232	By selecting RS232 interface, you need to configure baud rate settings both on your PC and the mobile computer.
USB VCOM	By selecting USB Virtual COM for the transmission interface, your PC and the mobile computer should be connected with a USB cable before the update can be done.
Bluetooth	By selecting Bluetooth for the transmission interface, you select to approach a Bluetooth enabled device for kernel update.
SD Card	By selecting SD card for interface, you select to access the SD card inserted in the mobile computer to carry out kernel update.
USB VCOM_CDC	By selecting USB Virtual COM_CDC for the transmission interface, your PC and the mobile computer should be connected with a USB cable before the kernel update can be done. This option is available only when USB Virtual COM_CDC is in use.

Baud Rate

Available baud rate options: 115200/57600/38400/19200/9600 bps

KERNEL UPDATE VIA BLUETOOTH

- 1) Go to **Kernel Menu | 4. System Menu | 7. Bluetooth Menu | 3. Security**, and configure the following Bluetooth settings first.
 - ▶ Authentication
 - ▶ PIN code
- 2) Go to **Kernel Menu | 2. Kernel Update** and select Bluetooth.
- 3) Start the pairing procedure from your PC, for example, click [Pair Device] and/or [Connect Bluetooth Serial Port].
- 4) On your PC, run the download utility ProgLoad.exe. In [Comm setting] group box, make the following settings:
 - Select RS-232 for [Comm type], so as to access Bluetooth SPP.
 - Configure [COM port] properties according to the Bluetooth COM port created on your PC. Go to **start | Control Panel | System | Hardware | COM & LPT** to check it up.

KERNEL UPDATE VIA SD CARD

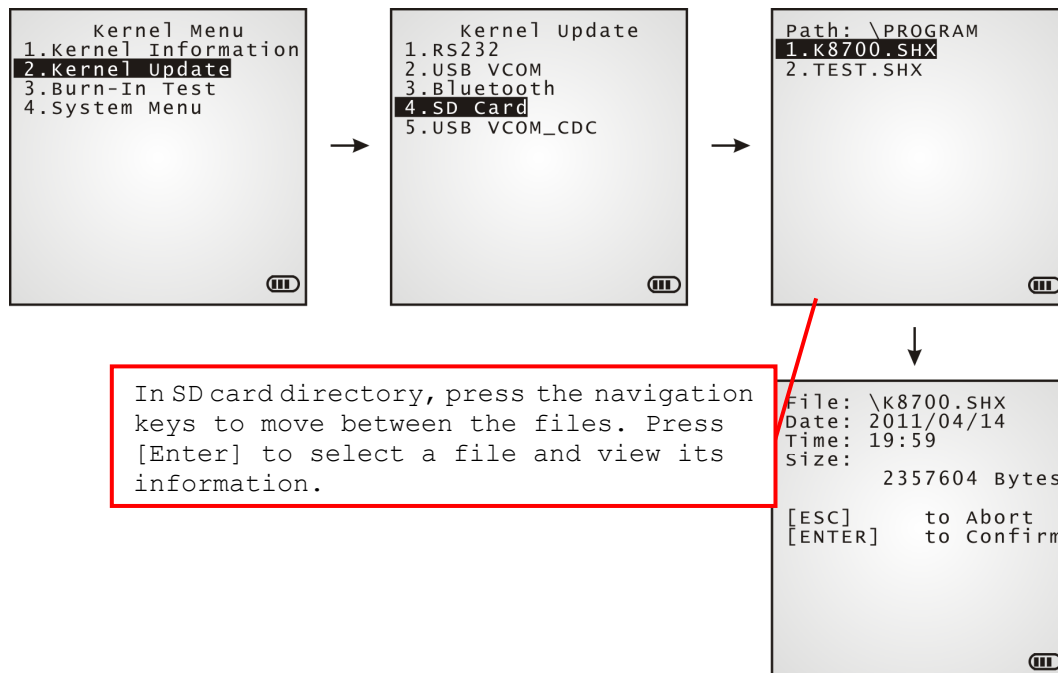

- 1) If the desired program file(s) has been copied to your SD card, go to **Kernel Menu | 2. Kernel Update** and select **SD Card**. A list of all the files existing under the directory “\Program” on the SD card will display, as shown above:
- 2) Press the navigation keys [Up] and [Down] to move between the files.
- 3) Press [Enter] to view the information of the program file.
- 4) Press [Enter] again to confirm downloading the selected program file to the mobile computer.
- 5) Press [ESC] to abort the download task.

4.2.3 BURN-IN TEST

Launches the burn-in test that is intended for factory's manufacturing purpose.

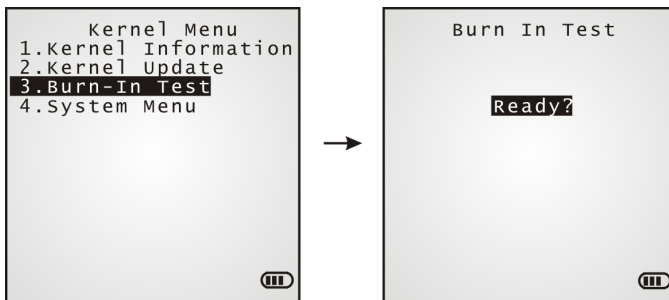

Warning! You should not perform this test.

4.2.4 SYSTEM MENU

Refer to [Chapter 3. System Menu](#) for details. This menu item is exactly the same as the **System Menu** for system configuration.

SPECIFICATIONS

Model Designation		8700	8770	8790
Wireless Communications	Bluetooth Class 2	√	√	√
	802.11b/g		√	√
	3.5G			√
Readers	Barcode Reader	<ul style="list-style-type: none"> ▶ CCD (linear imager) ▶ Standard Laser ▶ Long Range Laser ▶ 2D Imager 		
	RFID Reader	Frequency 13.56 MHz		
Electrical Characteristics	Main Battery	Rechargeable Li-ion battery – 3.7 V, 4000 mAh		
	Working Time	CCD, one scan per 5 seconds: <ul style="list-style-type: none"> ▶ 135 hours in batch mode (no communication active) ▶ 112 hours in Bluetooth mode (power saving) ▶ 60 hours in Wi-Fi mode (1 broadcast packet per second) ▶ 10 hours in 3G data connection 		
	Backup Battery	<ul style="list-style-type: none"> ▶ Rechargeable Lithium button cell – 3.0 V, 7 mAh ▶ Data retention – at least 25 days 		
	Power Adapter	<ul style="list-style-type: none"> ▶ Input: AC 100~240 V, 50/60 Hz ▶ Output: DC 5 V, 3 A ▶ Operating Temperature: 0 °C to 40 °C 		
Physical Characteristics	CPU	32-bit Toshiba CMOS type, 40 MHz		
	Memory	<ul style="list-style-type: none"> ▶ Program memory – 8 MB flash ▶ Data memory – onboard SRAM, 4 or 16 MB 		
	Display	Graphic LCD, 160 x 160 pixels, 3" FSTN with LED backlight programmable <ul style="list-style-type: none"> ▶ Font size 6x8: 26 characters by 19 lines ▶ Font size 8x16: 20 characters by 9 lines ▶ Overlaid with a touch screen that supports touch control via stylus and signature capture. 		
	Keypad	24-key or 44-key types, LED backlight programmable		
	Indicators	<ul style="list-style-type: none"> ▶ Two dual-color LEDs – red/green and blue/green, programmable ▶ Buzzer – 85db at 10 cm, 1 KHz, programmable 		
	Vibrator	9000 ± 2000 RPM, Max. 50 dB, programmable		

	Expansion Slot	microSDHC supported
	Enclosure Material	Rubber & ABS plastic
	Dimensions	230 mm (L) x 91 mm (W) x 65 mm (H)
	Weight	Approx. 600 g (Laser, battery included)
Environmental Characteristics	Temperature	<p>Operating: -20°C to 55°C</p> <ul style="list-style-type: none"> ▶ LCD gets acceptable view at -20°C ▶ Battery chargeable between 0°C to 40°C <p>Storage: -30 °C to 70 °C</p> <ul style="list-style-type: none"> ▶ Battery storage: 0°C to 50°C
	Humidity	<p>Operating: 10% to 90% RH, non-condensed at 60°C</p> <p>Storage: 5% to 95% RH, non-condensed at 70°C</p>
	Impact Resistance	1.5 m, 5 drops per 6 sides
	Splash/Dust Resistance	IP 64
	Electrostatic Discharge	± 15 kV air discharge, ± 8 kV contact discharge
Programming	Development Tools	C and BASIC
	Software & Utilities	FORGE Application Generator (AG), AG utilities; MIRROR Emulator (CipherNet) for VT100/220, IBM 5250 emulation; Download utilities, testing tools, etc.
Accessories		<ul style="list-style-type: none"> ▶ Pistol Grip ▶ Belt Holster ▶ Protective Cover ▶ Spare rechargeable battery pack ▶ Standard USB Cable ▶ RS-232 Cable ▶ Universal Power Adapter ▶ 308 USB Virtual COM Interface Cable (convert RS-232 to USB) ▶ Charging & Communication Cradle

DOWNLOAD UTILITY

For easy development of applications, the mobile computer ships with **FORGE Application Generator** programs, batch and WLAN versions, as well as a download utility.

FILE TYPES

Depending on the file type, a program or font file is downloadable through whether **System Menu**, **Program Manager** or **Kernel Menu**. These menus and the downloads supported are tabulated as below:

File Type	System Menu	Kernel Menu	Program Manager
Font file	√	–	–
AG runtime	√	–	√
CipherNet runtime	√	–	√
Kernel update	–	√	–
Bootloader update	–	√	–
BASIC program	√	–	–
BASIC runtime	√	–	√

FONT FILE

Font files (.SHX) are only downloadable through **System Menu**.

- ▶ Font file: Font-Multi-Language.SHX, Font-Japanese.SHX, and so on.

C PROGRAMS

C program files (.SHX) are downloadable through either **System Menu**, **Program Manager** or **Kernel Menu**.

The C programs at the service of the mobile computer can be categorized as follows:

- ▶ AG runtime: U8700.SHX, WU8700.SHX
- ▶ CipherNet runtime: 87xx-VT.SHX, 87xx-5250.SHX
- ▶ Kernel update: K8700.SHX
- ▶ Bootloader update: BL8700.SHX

Note: Kernel/Bootloader update is only downloadable via **Kernel Menu**.

BASIC PROGRAMS

To be able to download a BASIC program (.SYN) to the mobile computer via **System Menu**, you have to download a BASIC runtime (e.g. B8700.SHX) via **System Menu** or **Program Manager** first.

PROGLOAD.EXE

The utility "ProgLoad.exe" is provided for you to download a program (*.SHX, *.SYN or *.BIN) to the mobile computer. Run the program on your PC. The following dialog box pops up.

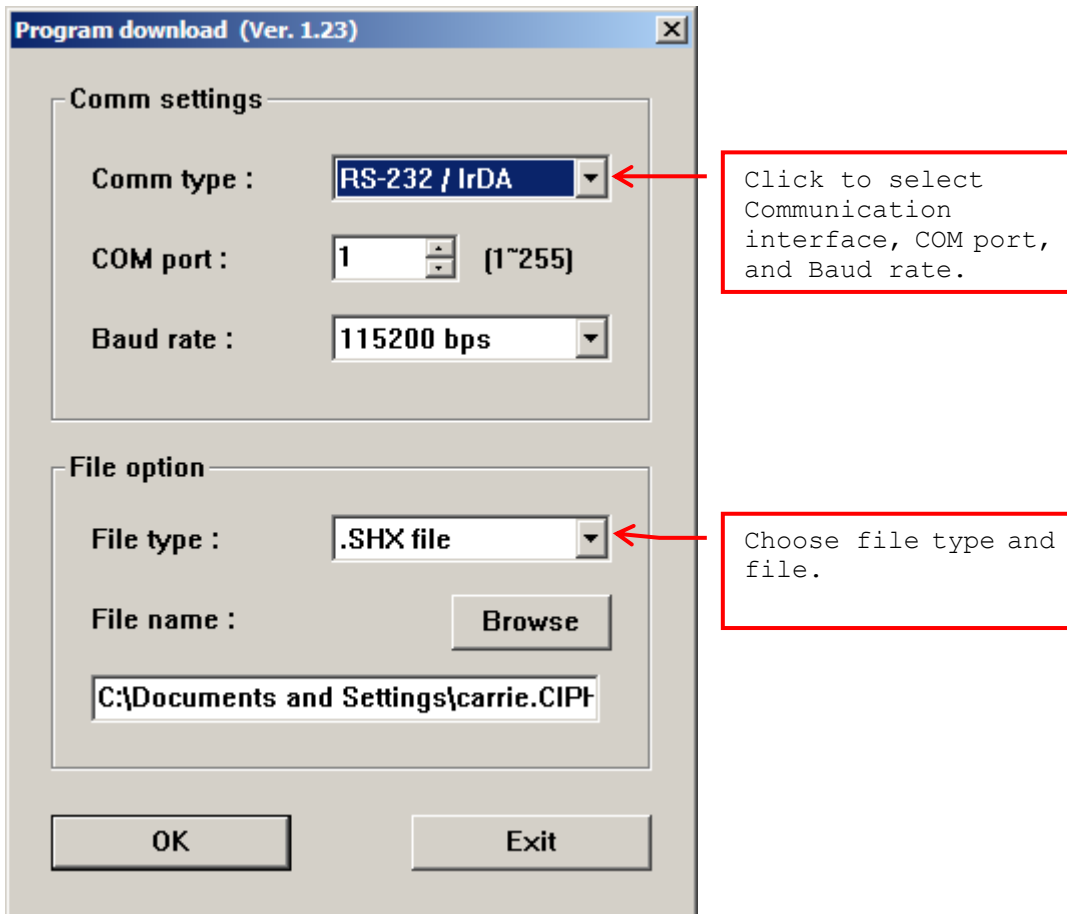

Communication Type

RS-232/IrDA	Connection via direct RS-232 cable, IrDA port, or Bluetooth SPP
Cradle-IR	Connection via cradle
TCP/IP	Connection over networks

File Type

.SHX file	C programs such as AG Runtime, Basic Runtime, font file, etc.
.SYN file	Basic programs (the pre-installation of Basic Runtime is required to download any Basic program)
.BIN file	The C programs converted from .SHX to .BIN by the utility "SHX2Bin.exe".

Note: (1) For 8700, USB Virtual COM shares the interface option of RS-232/IrDA.
 (2) Cradle-IR is not supported on the mobile computer.

TROUBLESHOOTING

CANNOT TURN ON WHEN PRESSING POWER KEY

- ▶ Make sure the battery pack is installed properly.
- ▶ Re-charge the battery inside the mobile computer and monitor the charging status. (See [3.5 Power.](#))
- ▶ If the battery is faulty, replace it with a fresh and fully charged battery.

CHARGING ERROR

- ▶ If using the USB cable for direct charging, make sure a suitable charging current is selected. (See [3.2.10 USB Charge Current.](#))
- ▶ If joining the power adapter to the USB or RS-232 cable, make sure it is well connected between the power jack and an outlet.
- ▶ If using a cradle, make sure the power cord is well connected the cradle and an outlet.
- ▶ Check if the battery contacts of the battery itself and the battery compartment are clean.
- ▶ Try to re-charge the battery and monitor the charging status by the mobile computer's **System Menu**. (See [3.5 Power.](#))

Warning! Be sure to use the batteries or charging device manufactured by CipherLab only. The use of wrong battery or charging device could result in damage to human body or the product itself, and will void your warranty.

BUZZER SEEMS NOT WORKING

- ▶ Perform the buzzer test. (See [3.3.2 Buzzer.](#))
- ▶ If the problem persists, reload the battery pack and perform the test again.

LED INDICATOR SEEMS NOT WORKING

- ▶ Perform the LCD & LED test. (See [3.3.3 LCD & LED.](#))
- ▶ If the problem persists, reload the battery pack and perform the test again.

LCD TOUCH SCREEN SEEMS NOT WORKING

- ▶ Perform the touch screen test. (See [3.3.6 Touch Screen.](#))
- ▶ If the problem persists, reload the battery pack and perform the test again.

KEYPAD SEEMS NOT WORKING

- ▶ Perform the keyboard test. (See [3.3.4 Keyboard](#).)
- ▶ If the problem persists, reload the battery pack and perform the test again.

VIBRATOR SEEMS NOT WORKING

- ▶ Perform the vibrator test. (See [3.3.7 Vibrator](#).)
- ▶ If the problem persists, reload the battery pack and perform the test again.

MOBILE COMPUTER SEEMS NOT WORKING

- ▶ Upload all data to the host and perform the memory test. (See [3.3.5 Memory](#).)
- ▶ If the problem persists, reload the battery pack and perform the test again.

CANNOT SCAN BARCODES

LOW BATTERY CONDITION

- ▶ Check if the battery icon on the screen indicates a low battery status. If so, replace it with a fresh battery.
- ▶ If the problem persists, check if the battery contacts get dirty or the battery pack does not fit to the compartment.

BARCODE OR RFID READER PROBLEM

- ▶ Perform the reader test to see if the reader is working. (See [3.3.1 Reader](#) or [3.3.9 RFID](#).)
- ▶ If the problem persists, reload the battery pack and perform the test again.

CANNOT DECODE DATA AFTER SCANNING

UNREADABLE BARCODE

- ▶ Check if the barcode is defaced. A defaced barcode may not be readable.

UN-PROGRAMMED TO READ

- ▶ Check if the scanner is programmed to read the symbology (types of barcode) that you are trying to read.
- ▶ Try scanning a test barcode of the symbology you are trying to read.

DIRTY SCAN WINDOW

- ▶ Check if the scan window gets dirty. Wipe it with a clean and dry cloth, and try again.

OUT OF SCANNING RANGE

- ▶ Try adjusting the scanning distance from the scanner to the barcode.

CANNOT TRANSMIT/RECEIVE DATA

USING RS-232 CABLE

- ▶ Check if the RS-232 connection is correct and secured.
- ▶ Make sure the serial port settings on your PC are consistent with the serial parameters on the mobile computer. Try to establish connection again.
- ▶ If the problem persists, run the Echo Test to check if the RS-232 interface between the mobile computer and your PC is working. (See [3.3.8 Echo Test.](#))

USING USB CABLE

- ▶ Check if the USB connection is correct and secured.
- ▶ Check if the USB driver has been installed.
- ▶ If the problem persists, run the Echo Test to check if the USB interface between the mobile computer and the host is working. (See [3.3.8 Echo Test.](#))

Note: (1) If you are using USB Virtual COM for the first time, you must install its driver from the CD-ROM. Driver version 5.3 or later is required. Please remove older versions! The virtual COM port will not be assigned until the USB port is in use.
(2) If you are using USB Virtual COM_CDC for the first time, you must install its driver from the CD-ROM. USB CDC driver installer can be found in the "Windows" folder. It will proceed to install the driver to your PC.
(3) A standard USB cable releases a COM port in the following conditions: (i) the cable is detached from the mobile computer directly, (ii) the cable is detached from the cradle directly, (iii) the cable is attached to the cradle, but the mobile computer is removed from the cradle, (iv) the mobile computer is powered off, (v) no application that requires a virtual COM port is running on the mobile computer.
(4) For an application program that requires a COM port to be occupied all the time, it is suggested that you use a 308 USB Virtual COM Interface cable instead.

VIA BLUETOOTH

- ▶ Make sure the distance between the mobile computer and a target device is within proper range. Try to establish connection again.
- ▶ Check if the relevant settings are correct. (See [3.7 Bluetooth Menu.](#))
- ▶ If the problem persists, run the Echo Test to check if the connection is working properly. (See [3.7.4 Echo Tests.](#))

VIA WI-FI

- ▶ Make sure the mobile computer is connected to an access point properly, under the same SSID. Try to establish connection again.
- ▶ Check if the relevant settings are correct. (See [3.10 Wi-Fi Menu](#).)
- ▶ If the problem persists, run the Echo Test to check if the connection is working properly. (See [3.10.5 Echo Tests](#).)

KEY REFERENCE TABLES

24-KEY KEYPAD

SYSTEM DEFAULTS

Key	[a] key pressed once	[a] key pressed twice	Key	[fn] key pressed once	[fn] key pressed twice
1	Space	Space	1	F1	1
2	ABC	abc	2	F2	2
3	DEF	def	3	F3	3
4	GHI	ghi	4	F4	4
5	JKL	jkl	5	F5	5
6	MNO	mno	6	F6	6
7	PQRS	pqrs	7	F7	7
8	TUV	tuv	8	F8	8
9	WXYZ	wxyz	9	F9	9
-	+\$_	+\$_	-	-	-
0	/*	/*	0	F10	0
.	%#;,	%#;,	.	.	.

44-KEY KEYPAD

SYSTEM DEFAULTS

Key	[a] key pressed once	[a] key pressed twice	Key	[fn] key pressed once
1	A	a	1	^
2	B	b	2	&
3	C	c	3	⏏+
4	D	d	4	[
5	E	e	5]
6	F	f	6	⏏-
7	G	g	7	<
8	H	h	8	>
9	I	i	9	?
-	J	j	-	\$
0	K	k	0	%
.	L	l	.	#

Key	[a] key pressed once	[a] key pressed twice	Key	[fn] key pressed once
F1	M	m	F1	+
F2	N	n	F2	-
F3	O	o	F3	*
F4	P	p	F4	/
F5	Q	q	F5	=
F6	R	r	F6	F16
F7	S	s	F7	F17
F8	T	t	F8	F18
F9	U	u	F9	F19
F10	V	v	F10	F20
F11	W	w	F11	F21
F12	X	x	F12	F22
F13	Y	y	F13	F23
F14	Z	z	F14	F24
F15	null	null	F15	–